



THE DISTRICT 20 TRUMPET

www.ACBLD20.org



Vol. 14, No. 3

Bridge Across the District

Fall 2018

Size of board continues to be an issue

In July I attended the Summer NABC in Atlanta. The table count was 11,268 tables, up from six years ago. The board of directors is hoping this upward trend continues and I hope you have all made your plans to attend the November NABC in Hawaii.

One of the issues that the national board continues studying is restructuring of the board itself. Many believe

that 25 members is too big and too expensive to run the organization properly. Many proposals have been made but nothing concrete is in the works.



Merlin Vilhauer

D20 District Director

A smaller board would reduce expenses, but the people remaining would be stretched thin on

being able to serve the players. I will keep you posted about developments.

Another of my concerns in restructuring is that districts like ours which have such a large geographical area but a smaller population will lose their voices to the big East Coast cities.

Continued on Page 18

D20's results from the Atlanta NABC

District 20's best performance at the Summer NABC in Atlanta came in the Grand National Teams Flight C, in which **Kevin Marnell, Frank Straulemann, Roger Thomas, Jon Gassaway, Andrew Nuxoll and Dan Edelstein** reached the semifinals.

Four D20 players placed in the Wernher Open Pairs, playing with partners from elsewhere: **Dan Hoekstra** 10th, **Jeff Roman** 11th, **Chris Gibson** 25th and **Dan Neill** 29th. Roman also placed sixth in the Truscott/USPC Senior Swiss Teams.

Five D20 players placed in Flight B national pairs events. In the Young 0-2500 Pairs, **Ray Robert** and **Rick Prouser** placed 17th and **Chuck Swart** 21st. **Don Weber** and **Ellie Hood** placed 19th in the Bean Red Ribbon Pairs.

In regional events, **Dawn Campbell** won the Friday open pairs and Gibson won a bracket 2 knockout. Swart and **Jim Wisner** were second in the International Fund Pairs. Robert and Prouser were second in the Thursday B/C Pairs.

In I/N events, **Chris and Cindy Meyers** of Dallas OR placed second in F in the Friday morning 299er pairs.

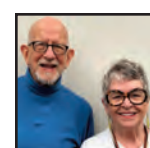
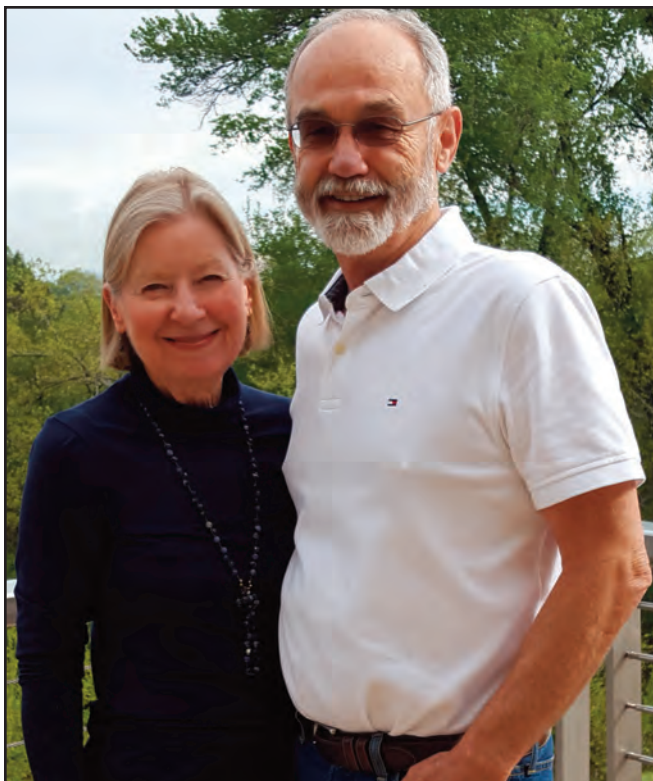
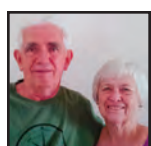
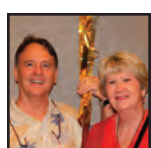

Jamie Newman and Ron Jauch, along with nine other married couples, discuss their partnership.

Till bridge do us part?

Married couples discuss the challenges of playing together

Stories by **Jen Smith, Chip Dombrowski and Jim Flint**

The Trumpet

Everyone knows things can get tense between bridge partners, especially when your partner also happens to be your spouse.

The most famous example of a marital bridge spat gone wrong is when Myrtle Bennett shot her husband back in 1929.

The Bridge Bulletin featured in its August issue a haiku contest, and some of the winning entries touched on the marriage/partnership combination:

The love of my life sits across the bridge table bidding who knows what
— Mark Rissman, *The Villages, Fla.*

Married 80 years without a single cross word took up bridge: divorced
— Alan Levine, *Massapequa, N.Y.*

Luckily the 10 couples we're about to introduce have fared far better with their significant others at the bridge table. Meet a group of people who can relate to these haiku but have different stories to tell.

Continued on Page 10

Volunteering: Easier than you think

District seeks representative to Board of Governors

Bridge has given me so many things: friends, a way to express my competitive spirit and a game that stimulates the brain.

It was never my intent to get involved other than happily playing bridge. Of course, I did simple things that we all do at the club, clearing my coffee cup, taking out trash, etc. At the unit games, I helped with cleaning up. At sectionals, I might do more — loading card tables and chairs, bringing food. I hope most of us do these basic things.

I was then approached to be on the unit board and accepted, which truly didn't take much time, even the year I was president. When I was asked to be area representative, I had to give that

some thought but enjoyed it and learned much more about District 20 and ACBL. I'm glad I was elected district president and hope to serve D20 well.

We are in need of someone to fill a board of governors position and I hope a volunteer will step forward. The representative is expected to attend at least one meeting of three each year at nationals. That board acts as a liaison between the members and the ACBL board of directors. You can read more about the position and the application process in our by-laws.

Feel free to contact me if you are interested



Laurie Rowe
D20 President

Continued on Page 2

Boise beats projections, holds level

Co-TM search continues

By **Amy Casanova**
The Trumpet

The second Great Potato Regional in Boise is now history, and there were many highlights.

It provided an opportunity for area players to attend **Barbara Seagram's** three-day seminar. Seagram has achieved rock-star status in bridge education, and deservedly so. She drew crowds of eager students, played several sessions and attended **Margi Redden's** I/N party.

Seagram is charming and gracious. What a great coup by **Deborah Lackey**, in her last tourney as education liaison, to book Seagram, who certainly could be credited for attracting players. Bucking the trend of significant table falloff, the count was only slightly down from 2016, a mere eight tables — a drop of only 1%.

Tournament Manager **Jim Wheeler** stayed calm under pressure as the venue provided some challenges. The hotel seemed understaffed and

Continued on Page 18

Seaside beach beckons you

Are you ready for the beach and bridge on our beautiful Oregon coast?

Seaside and your District 20 tournament directors are ready to welcome you. This year's dates are Oct. 1-7. Game times are 9, 1 and 7.

I/N players can look forward to many opportunities to earn gold points. There is a section on the tournament flyer that highlights those events (see page 16). You can access at the D20 or ACBL website a more complete version than the one on page 9.

The convention center is under construction for a major remodel, so we may experience some inconvenience. However, the convention center management has promised to take good care of us.

I look forward to seeing you at the beach!

Tournament manager **Jim Wheeler** can be reached at jimpamw@yahoo.com or 503-860-0563.



Jim Wheeler
Tournament Manager

A good partner is good to find; three is better

I've often thought one of the hardest aspects of bridge is finding and keeping a good partner (cue Mae West joke now). Many bridge partnerships are forged in friendship, others random pairings that flourish, some never quite catch fire and fizzle after a few below-average sessions.

How much time and effort should one invest in a partner, and in the game? It depends on your goals. I think it should be important to be clear and up front when beginning a new partnership, as it's a lot like a relationship. If there were an on-line site or app for bridge partners as there is for dating, what kind of questions or statements would be appropriate? Instead of "long walks on the beach, candlelit dinners and jazz," might you say, "2/1, UDCA, 1430, weak jump shifts"?

Maybe what is also necessary is to announce your commitment level, both time-wise and in the sense of growing your game. It's perfectly fine to not care about tournaments and travel and be content to play locally and/or socially. If you're out there gunning for every regional and sectional and want to go to the nationals, it's a good idea to find a partner who is on the same page, unless you're OK finding yourself at the partnership desk.

Let's also be realistic about our skill level. You might be better than your masterpoint accumulation. Masterpoints aren't always a good indication of talent. Define the strongest and weakest aspects of your game and be honest about what you're working on. Playing with a partner who has more experience than you can help your game immeasurably — if you are willing to listen and learn and can handle the pressure of not wanting to let them down.



Amy Casanova
Managing Editor

I am fond of saying it's best to have three types of partners. I know, it can be so hard to find one, but ideally you might have one you learn from, one you learn with and one you teach. Maybe you think you don't know enough to teach someone, but someday soon you will, and you can reinforce your own knowledge by imparting it to a newbie.

In essence my player roundup question was what makes a good partner by asking what would make you want to say goodbye to one. I asked one of my better partners (I am incredibly fortunate to have several whom I learn from, in fact maybe all of them) what he liked about playing with me. He said that I cared. It sounds pretty simple, but it's deceptively deep. Care enough to go over your mistakes and learn, to study even just a little bit, to

Mae West

We combed the witticisms of Mae West for the top five quotes most pertinent to bridge. If these results shock you, then you probably need to be shocked more often.



Mae West

5. "I generally avoid temptation, unless I can't resist it."
4. "The score never interested me, only the game."
3. "Between two evils, I always pick the one I never tried before."
2. "To err is human — but it feels divine."
1. "Good sex is like good bridge. If you don't have a good partner, you'd better have a good hand."

watch the cards; especially the small ones. Those things can make a big difference, not only in your game but in the vitality of your partnerships.

You're going to make mistakes, believe me. Just try to make them good mistakes and quit making the dumb ones. And instead of the tired old Mae West quote, how about this one, which I think works for bridge quite well: "Good judgment comes from experience. And experience? Well, that comes from poor judgment."

Amy Casanova can be reached at trumpeteditor@gmail.com.



The Seaside promenade

Rowe

Continued from Page 1

at district20pres@gmail.com.

At the Boise regional, I enjoyed fabulous food, great bridge and connecting with my bridge friends. Table count was better than anticipated and Barbara Seagram's seminar was well attended.

See you in Seaside!

D20 President Laurie Rowe can be reached at district20pres@gmail.com.

Deaths

Ken Aalto – 73, of Eureka CA died June 15, 2018.

Richard Brumund – 75, of Eugene OR (formerly of Phoenix OR) died July 31, 2018.

Kathy Callahan – 71, of Redding CA died July 5, 2018.

Fred Coburn – 84, of Eugene OR died July 18, 2018.

Polli Dense – 79, of Redding CA died May 18, 2018.

Evelyn Duncan – 88, of Malin OR died June 30, 2018.

Phyllis Hann – 98, of Salem OR died June 9, 2018.

Bob Lorenson – 85, of Eureka CA died July 9, 2018.

The Trumpet on Facebook
www.facebook.com/d20trumpet



The District 20 Trumpet
Vol. 14, No. 3 • Fall 2018
© 2018 D-20 Organization

Official publication of the
American Contract Bridge League
District 20
6512 SW Midmar Place
Portland OR 97223-7517
Phone: (503) 244-5733
www.acblid20.org

The District 20 Trumpet is published four times a year in March, June, September and December. It is distributed free to clubs in Oregon and Northern California and small parts of Washington and Idaho. All sectional announcements are free.

Managing editor: Amy Casanova
Designer/Editor at large: Chip Dombrowski
Copy editor: Jim Flint
Senior writer: Jen Smith
Ads: Susan Chambers, Sunset Bay Media
Printing: Oregon Lithoprint, McMinnville, OR

Deadlines: The deadline for the Winter 2018-19 issue is Sept. 28 for free sectional ads and advance articles. The deadline for unit reports is Monday, Oct. 15. The deadline for front-page articles is Oct. 31. Please send to managing editor Amy Casanova. Email trumpeteditor@gmail.com; phone 503-753-9395; mail: 2310 NE 8th Ave. #7, Portland OR 97212.

New Life Masters: Please send a photo for publication by email.

Choosing the evil I haven't tried before

A week after wrapping up the summer Trumpet, I headed off to Cincinnati for a week at my newest – and at the moment only – annual tournament. I can drive there in a day and have free housing. When I was there last year, I met some people I like to play with. And it's scheduled during one of my only real breaks from the Trumpet, all of which adds up to a great reason to go back.

It was my first tournament in nine months, and I'd only been to one club game in six months. I expected to be rusty. I was pleasantly surprised the first couple days to find myself playing about as well as I ever have.

I did a player roundup a few years ago in Seaside about the hardest thing to learn at bridge. I believe the consensus was discipline — when to pass. No one who's ever played with me is going to believe this, but I've been working on that. You might even say I was a model of discipline in Cincinnati.

Even when you see how well it's working, it's hard to maintain it. I made it through the whole first day – 48 boards – without stepping out on a single bid. I made it through the first session the second day. I made it through 22 boards the second session, which was the final of a knockout.

Finally, after 94 boards of good behavior, I felt I'd earned the right to indulge myself. On the penultimate board I broke down.

I've never had any vices, because I've never wanted to. For me, rebidding my club suit vulnerable at the four level when I've already shown my hand is as real as temptation gets. They didn't even double me, because why would they double someone who's had his bid every time for 22 boards? Like I said, you wouldn't recognize me.

They didn't need to double. I played 4♣ down three vulnerable while our teammates made a partscore, costing us 5 IMPs. We ended up losing the match by 4. Is that cosmic justice or what? Yes, every person on the team made mistakes, and

any one of them could point to a blunder that blew at least 5 IMPs if not more.

It's not about fault. It's more about how close I came to not having any major bidding errors, which was a new experience for me, to say the least. I've been a risky player, and blowing my share of IMPs comes with the territory.

This time I made a decision that I knew was more likely to be wrong than right because I couldn't resist the temptation, even though I'd been resisting it to great success for two whole days.



Chip Dombrowski
Editor at Large

A large part of my early bridge success was an uncanny tendency to get rewarded for my bad bids far more often than I got punished. There's such a rush that comes from getting away with something. On account of my lack of a rebellious youth, I didn't experience that buzz until I started playing bridge.

There is an art form to sniffing opportunities to rob the opponents, but you realize as you move into the bigger leagues that those chances diminish. It's important to be alert to those opportunities when they arise, but it's dangerous to be chasing them on every hand.

Still, as good as it feels to play well and win, it feels so much better to break all the rules and win. That's why it's so hard to learn discipline. If you think there's a chance you'll get away with it, it's hard to turn it down in favor of the slow-and-steady approach.

I think it was my last time in Seaside three years ago when I found myself playing 6♦ making six while the other table played 4♦ making four. The truth is we were both in the wrong contract. It makes five legitimately. But they didn't get their tricks, and my punishment for bidding one too many was winning 15 IMPs rather than 10 (the reward for 5♦). I could have lost 6.

We can agree it's not right to risk 16 IMPs to get 5 more, but that doesn't change that it feels great to do it when it pays off. (As Mae West said: "To err is human, but it

feels divine.") Of all the getting-away-with-something rushes in bridge, I think making a lucky slam is the best.

How about a grand? This one isn't lucky. You hold:

♠A J 4 2 ♥A ♦A K Q 8 2 ♣K 10 9.

You're in first seat, red against white, at matchpoints. It's pretty easy to open 1♦ and plan to jump shift in spades after partner bids 1♥, but what happens when partner bids 1♠?

All of the rebid choices are flawed. A splinter shouldn't be on a stiff ace, and a jump to game should be balanced. You might move straight to Blackwood, but are you going to find out what you need to know? Though it's a diamond short, 4♦, showing a strong hand with a fit for spades and a long, strong diamond suit, is also a possibility.

I chose 4♠, which was deemed a massive underbid by an expert panel, who opted for the splinter, despite the ♥A, as the most productive move toward slam.

However, partner happens to be loaded, so you don't really have a way to go wrong on this hand. Any strong bid is going to prompt him to ask for key cards. When I showed three, partner bid 5NT, confirming he had the other two plus the ♠Q and asking me to show my lowest outside king.

I went straight to 7♠. I have the ♣K, the ♦K and a singleton heart — second-round controls in all three side suits. Whatever my partner is looking for, I have it.

It makes, and we get a top board. I heard from other pairs in the field that "there's no way to bid the grand." Well, not if I make the robotic bid of 6♣.

When I arrive in Seaside next month, it will be my first time playing real bridge since Cincinnati, and those will be my only two tournaments this year — a long way down from 20 a few years ago. I'm looking forward to seeing all my Northwest bridge friends.

Perhaps you'll notice a difference. But let's be real: I'm not making any promises about a 94-board streak of discipline.

Chip Dombrowski can be reached at chip.dombrowski@acbl.org.

NAP AND GNT

How GNT teams fared; NAP coming soon

The GNT finals in Atlanta gave our four D20 teams a chance to measure themselves against teams from all over the ACBL.

Our open team of **John Ashton, Dennis Metcalf, Jim Elliot, Marc Zwerling, John Lusky** and **Randy Pickett** finished 11th in the Swiss qualifying for the KO phase. The random draw placed them against the Martel-Stansby-Woolsey team, with its many national champions, who were too strong for our guys.

Our flight A team of **Joel Datloff, Michael Redden, Craig Jones** and **Charlene Martindale**, augmented by **David Brower** and **Linda Wiener**, were 0.34 VP short of advancing in the qualifying Swiss.

Our flight B team of **Rick Prouser, Ray Roberts, Chuck Swart** and **Jim Wisner** did not have a good day.

District 20 was well represented by its flight C team of **Dan Edelstein, Andrew Nuxoll, Jon Gassaway, Roger Thomas, Kevin Marnell** and **Frank Straulemann**. They came in sixth in the qualifying Swiss and continued on in the KO portion where they won two matches. They beat the sec-

ond seed by 40 in the quarterfinals before losing in the semifinals. They finished third/fourth in the nation. (See story, page 8.)

2019 GNT and subsidies

Qualifying for the 2019 Grand National Teams is going on now and runs through the end of February. Clubs throughout the district will be having qualifying games. Our qualifying requirements are very generous. We want everybody to play. I will help you form teams and find playing venues. Win a trip to Las Vegas next July.



Hal Montgomery
NA Events Coordinator

The subsidies have changed since last year. We now allocate \$200 per team, up to a maximum of nine, that play in the finals of each bracket, toward the team subsidy for that bracket. We further augment the subsidy with \$300 per flight from our Grass Roots Fund. The maximum total is now \$2,100, among the most generous in the ACBL. I hope we get the full amount in each bracket.

NAP

The online finals of our North American

Pairs are Oct. 20 for flights A and C and Oct. 21 for flight B. You must have qualified in a club to be eligible. The NAP is for players of all ability ranges. We have three brackets in the NAP finals and qualify 11 pairs for the nationals. Get your friends and partners together and plan your own bridge party if your local club is not hosting a venue. If you need help finding partners and/or a venue, please contact me. Win a trip to Memphis with its fabulous barbecue. D20 continues to add to the subsidies that are provided by the ACBL.

Our online finals are an opportunity for players to compete against players of their own ability level and win gold and red points without having to travel. You can get together at a friend's house, play bridge, eat party food and win gold points.

In our GNTs last spring, we had bridge parties at private homes in four states.

A complete breakdown of the subsidies provided by D20 in both the NAP and GNT is available on the D20 website.

Hal Montgomery can be reached at dewitt@imaginata.com.

Laws of the Game Making a proper claim

You're the declarer in a notrump contract. You've just won a trick with the ♠A in your hand and now, with only five tricks left to play, your hand is ♥AKQJ10. Obviously, you could play out your hearts one by one, but why should you? You know you're going to win all five tricks, so don't waste everyone's time. Make a claim.

Of course, it's not always that easy to see you'll take all the remaining tricks, especially in a suit contract where you just might have forgotten to pull all the trump, or where you've

forgotten that a king has yet to appear and is, unfortunately, offside.

So what's the correct procedure for making – or defending – a claim?



Dennis Kendig
Trumpet Contributor

First, declarer announces that he will win a certain number of tricks. It

need not be all remaining tricks; he may concede an ace, for example.

Second, he faces his cards, placing them *on the table* for all to see.

Third, and most importantly, he must *state the line of play* he intends to follow to take the tricks he has claimed. This is critical because declarer will be bound by this line of play, and cannot change it if he learns that there is a potentially fatal defect, a missing trump, for example. If declarer fails or declines to state a line of play, defenders should immediately call the director.

If declarer states a line of play, and it is clear that he will indeed take the promised number of tricks, the defenders may accept the claim, and the hand will be completed and scored accordingly.

As of Jan. 1, 2018, if all four players agree, they may play out the hand, starting with the first step of declarer's line of play, without calling the director.

But what if one of the defenders believes the claim is invalid? *Call the director*. The director will confirm that the declarer has stated a line of play, then will have all parties face their cards and will determine if the claim is proper.

Under no circumstances should a defender volunteer information that

Continued on Page 6

Strategic Thinking

Declarer strategy: Choosing your line of play

In my previous articles, I focused mostly on bidding strategy. It's now time to move on to cardplay strategy, and first we'll see how to be a strategic declarer.

An average declarer in an average field will be declarer around a quarter of the time. When you are declarer, you can't count on partner to help you, so it is very important to have your own strategy, and to establish it as soon as dummy comes down. So every time you become declarer and your partner puts his hand down, you should pause and assess your options.



Louis Beauchet
Trumpet Contributor

Some hands may be straightforward, in which case your strategy can be set quickly. But others offer many different lines of play, and in these cases you should decide which one to adopt before playing to trick one; so many mistakes are made because declarers play too fast at trick one.

Once you have chosen your line of play, you have to display your declarer skills to follow it. Here I'm going to explain how to choose your line of play. But because that strategy differs a lot whether you are play-

ing IMPs or matchpoints, we'll need to study both types of game.

In this issue, we'll talk about IMPs games.

In IMPs, your main (if not only) goal is to make your contract. Overtricks don't really matter (they are worth 0 to 2 IMPs depending on what contract your teammates are defending), but going down in a contract because you unsuccessfully tried for an overtrick can cost up to 17 IMPs.

So when you are declaring a hand at IMPs, you have to choose the line of play that has the best chance to lead you to the number of tricks you need to make your contract. That means you sometimes have to adopt unusual lines of play. Take this example. As declarer, you hold:

♠AKJ43 ♥K4 ♦Q63 ♣K62,

and dummy comes down with:

♠752 ♥QJ53 ♦AK2 ♣AQ5.

The contract is 4♠ and the opening lead is ♣J. At IMPs, your goal is to take 10 tricks. So you win the ♠A and play a spade to the jack. Wrong! On a bad day, your LHO will win the ♠Q, give your RHO a club ruff, get in with the ♥A and give RHO a second club ruff. Down one.

You should instead win the club lead and cash the ♠AK, giving you a 100% chance

to make your contract, unless your RHO started with all five spades, but in that case there was nothing you could have done.

Here, choosing a safe route to 10 tricks at trick one will occasionally lead to big swings in your favor. But sometimes, it's the opposite. If you are declaring a desperate contract at IMPs (we've all been there) and need a miracle to make it, go for it. Imagine the only layout that would allow you to make your contract and base your line of play on this miracle layout. If you go down an extra trick or two, the loss will be small. But if you get lucky and make your contract, the win will be huge.

Follow these guidelines and you will improve your results:

- ♦ Pause briefly before playing your first card (even if there is a singleton in dummy).
- ♦ Decide on how many tricks you think you need to make to get an average or better score (this will depend on the type of game you are playing in, on the strength of the field, on the contract you are in).
- ♦ Choose the line of play that has the best chance to lead you to your trick target (a slight chance is still better than nothing).
- ♦ Use your skills to realize your goal.

Next issue: *Strategy at matchpoints.*

Louis Beauchet, 17, is a Silver Life Master.

Vancouver Bridge Club

Unit 452

Non-Life Master Sectional Oct. 13-14, 2018

Saturday, 10 a.m.:
Saturday, 3 p.m.:
Sunday, 10 a.m. & TBD:

Morning pairs (single session, stratified)
Afternoon pairs (single session, stratified)
Sunday Swiss Teams (two sessions, stratified, 20-point victory scale)

Stratifications:

0-500 NLM: A=200-500; B=50-200; C=0-50

Strats are based on the average masterpoint holding of the pair or team.

FEES: \$9 per player per session; \$13 lapsed ACBL members (temporary memberships available)
Sunday lunch: \$5 includes sandwich and salad

Head Director: Rich Carle

Tournament Chair: Liz Fullerton, 360-258-1900; liz4bridge@gmail.com

Partnerships: Barbara Pyles, 971-275-4508; barbarapyles@gmail.com

VANCOUVER BRIDGE CLUB

6503 East Mill Plain Blvd., Suite H • Vancouver, Wash. 98661 • 360-737-3772
vbridgeclub@gmail.com • www.acbl20.org/vbc

NEW ACBL MEMBERS

Kerry Ach, Kailua HI	Dianne Hass, Corvallis OR	Joseph Morgan, Vancouver WA
Daniel Bender, Kaneohe HI	James Hey, Portland OR	Helen Moulton, Penn Valley CA
Craig Bennett, Bend OR	Michael Holladay, Payette ID	Michael Mullen, Meridian ID
Gerrie Booth, Longview WA	Doris Homan, Payette ID	Kristin Oishi, Honolulu HI
Marjorie Boulton, Corvallis OR	Hugh Homan, Payette ID	Judy Pfandler, Chico CA
Katharine Bowman, Portland OR	Myles Jones, Grass Valley CA	Marianne Rothenberger, Portland OR
Mary Brandt, Honolulu HI	Susan Jones, Grass Valley CA	Thelma Rueppell, Portland OR
Mark Chasse, Portland OR	Shelley King, Portland OR	Glenn Segal, Portland OR
Robert Coker, Penn Valley CA	Jan Knecht, Chico CA	Philip Simon, Vancouver WA
David Cook, Portland OR	Lenelle Kwong, Honolulu HI	Roger Speigle, Tualatin OR
Jeanne Deraeve, McMinnville OR	Jeanne Lawrence, Chico CA	Joyce Spoehr, Honolulu HI
Helen Esfandiari, Eugene OR	Yunsun Lee, Honolulu HI	Jan Sturdevant, Portland OR
Sally Flinn, Honolulu HI	Roberta Lee-Driscoll, Honolulu HI	Stuart Sutton, Honolulu HI
Dino Francois, Eugene OR	Grace Masback, Portland OR	Dana Takiguchi, Tigard OR
Richard George, Truckee CA	Denise Messer, Penn Valley CA	David Warner, Kailua HI
Carol Goldstick, Lake Oswego OR	Sandy Miskella, Chico CA	Susan Weakley, Wilsonville OR
Bobbie Greenlick, Portland OR		Gary Wheat, Chico CA
Cliff Greenlick, Portland OR		Wendy Wiltse, Kailua HI
Bruce Gulliver, Portland OR		Wing Yung, Salem OR

Welcome!

DISTRICT 20 RANK CHANGES

JUNIOR MASTERS

Robert Allen, Portland OR
Susan Alston, Medford OR
Diane Bending, Corvallis OR
Susan Circone, Lake Oswego OR
Keith Crudgington, Eugene OR
Cheryl Cullen, Ashland OR
Thomas Davis, Nevada City CA
Diane Deibele, Vancouver WA
Toshiko Dose, Honolulu HI
Helen Esfandiari, Eugene OR
Gail Foster, Culver OR
Bob Gebo, Beaverton OR
Gerald Heck, Bend OR
Hugh Homan, Payette ID
David Howard, Eugene OR
Diane Howard, Eugene OR
Betty Huckestein, Astoria OR
Susan Hutton, Ashland OR
Beulah Jueau, McMinnville OR
Lawrence Kinkor, Nevada City CA
Kim Krause, Crescent City CA
Elizabeth Lane, Ashland OR
Jerry Larson, Vancouver WA
Merry Lewis, Grant Pass OR
Joanne Martin, Chico CA
Tara McMahon, Portland OR
Christina Melies, Albany OR
Sheryll Moffat, Medford OR
Kathy Neuman, Brookings OR
Linda Nicholls, Kalaheo HI
Erik Ogaard, La Grande OR
Janice Olson, Grants Pass OR
Steve Parker, Portland OR
Doris Peckham, Meridian ID
Elton Richardson, Vancouver WA
Marylyn Russell, Portland OR
Jane Siemmens-Neary, Boise ID
Alberta Simic, Chico CA
Renee Sweet, Weiser ID
Carolyn Tragesser, Meridian ID
Christine Waters, Pahoa HI
Frederick Williams, Portland OR

CLUB MASTERS

Jack Allan, Boise ID
Margaret Ann Anderson, Kailua Kona HI
Nick Atanasov, Tigard OR
Meredith Baughman, Corvallis OR
Lynda Bishop, Portland OR
Bev Britton, Penn Valley CA
Jean Carroll, Grants Pass OR
Zach Collins, Portland OR

New Life Masters



Staci Christian
Lake Oswego OR



Nancy Feldman
Boise ID



Ron Foerster
Bend OR



Anita Hansen
Caldwell ID



Erik Hansen
Caldwell ID



Benjamin Levy
Vancouver WA



Kevin Marnell
Portland OR



Dan Neely
Boise ID



Frank Nemeth
Portland OR



Bruce Thornburgh
Boise ID

Congratulations!

Not pictured:

Mary Bell
Canyonville OR
Gloria Shagrun
Chico CA

REGIONAL MASTERS

Toni Albano, Portland OR
Brenda Biermann, Roseburg OR
Susan Braden, McMinnville OR
Kurt Browning, Grass Valley CA
Denise Cox, Eugene OR
William Elston, Keaau HI
Michael Freda, Nevada City CA
Norman Haller, Camas WA
Fran Henry-Jansa, Portland OR
Mark Jansa, Portland OR
William Kurz, Shingletown CA
Carol Macleod, Vancouver WA
Betty McCormick, Brookings OR
Herbert Nakagawa, Honolulu HI
Mary Pascale, Chicago Park CA
Jean-Pierre Perchellet, Salem OR
Judd Robbins, Ashland OR
Michael Sailor, Corvallis OR
Charles Shipley, Grants Pass OR
Kristin Steinmetz, Portland OR
Timothy Trinkle, Longview WA
Beth Unger, Portland OR
Bryon Van Fleet, Corvallis OR
Kay Ward, Portland OR
Thomas Warren, Longview WA

NABC MASTERS

Debbie Cole, Bend OR
Ginny Edmunds, Honolulu HI
Jeanette Hanna, Clackamas OR
Jeff Heyser, Penn Valley CA
Susan Hornung, Lake Oswego OR
Denise McElney, Gold Hill OR
Edwina Moscatelli, Honolulu HI
Joanne Ruyle, Portland OR
Joan Shafer, Pahoa HI
Ann Teal, McMinnville OR
Shirley Thomas, Beaverton OR
Michael Thurlow, Redmond OR
Cary Wirth, Nevada City CA

ADVANCED NABC MASTERS

Lisa Derock, Princeville HI
Rick Gardner, Arch Cape OR
Mike Goffe, Portland OR
Linda Smith, Corvallis OR

Mary Donley, Portland OR
Fredrick Goll, Salem OR
Barbara Harrison, Boise ID
Elsie Hathaway, Vancouver WA
Don Hilmer, Portland OR
Doris Homan, Payette ID
Matt Liberty, Lake Oswego OR
Spring Liberty, Lake Oswego OR
Don Martin, Medford OR
Ginger McCarthy, Portland OR
Larry Miller, Grants Pass OR
Barry Neuhaus, Bend OR
Ali Nice, Eugene OR
Martin Nice, Eugene OR
Sharon Sandell, Waianae HI
Jean Scholtz, Rockaway Beach OR
Greg Schweizer, Redmond OR

Raymond Teller, Bend OR
Carmen Von Sydow, Honolulu HI
Herbert Yussim, Bandon OR
John Zillman, Kalama WA

SECTIONAL MASTERS

Jo Alvin, Albany OR
William Anderson, Portland OR
Judy Blankenfeld, Hilo HI
Greta Britt, Portland OR
Charles Carter, Brookings OR
Kate Claeys, Kamuela HI
Karen Ehrhorn, Kailua HI
Maryon Evans, Nampa ID
Judy Farrell, Portland OR
Warren Glaze, Brookings OR
Bruce Hanni, Eagle ID

Kathleen Hart, Portland OR
Laura Herman, Roseburg OR
J. Heston, Portland OR
Jayne James, Boise ID
Frances Janssen, Redding CA
Roma Johnson, Kailua Kona HI
Stephen Kingsbury, Beaverton OR
Jane Lackey, Corvallis OR
Ellie Lathrop, Longview WA
Shirley Layne, Salem OR
Dana Marble, Columbia City OR
Sue McMullen, Eugene OR
Marie Muller, Longview WA
Paul Panico, Bend OR
Claire Thomas, Corvallis OR
Sheryl Williams, Portland OR

Gold Country Sectional October 12-14, 2018

St. Canice Center
236 Reward St.
Nevada City, CA 95959



Friday, Oct. 12
10 a.m. and 3 p.m.

- 10 a.m. 299er pairs - single session
 - Stratified Open Pairs - 2 single sessions
- 3 p.m. NLM Pairs <500 MP - single session

Saturday, Oct. 13
10 a.m. and 3 p.m.

- 10 a.m. 299er pairs - single session
 - Stratified Open Pairs - 2 single sessions
- 3 p.m. NLM Pairs <500 MP - single session

Pairs stratifications based on pair average:

A: 2000+; B: 750-2000;
C: 0-750 (NLM)

Sunday, Oct. 14
10 a.m. & 2:15 p.m.

- Sunday Swiss Teams
 - 20 Victory point scale - afternoon session; short lunch on your own, sandwiches available for purchase
 - A: 1500+; B: 500-1500; C: 0-500 based on average MP per team
 - Single session teams allowed
- Strats for all events may be adjusted by the director based on the masterpoints of players in the event*

Card fees per session

- \$10 ACBL members
- \$14 for lapsed ACBL members
- \$2 under 18

General information

Jim Hook
(530) 432-5593
Hook13253@comcast.net

Barbara Langdon
(530) 265-8030
jonbar@att.net

Partnerships

Bruce Lester
(530) 477-9586
bvlester@att.net

Directions

Note: for locals, Reward St. is off Zion St. and within 1 block of SPD in Nevada City.

From Grass Valley, take Hwy CA 20 E/49 N toward Nevada City. Exit at Ridge Rd./Gold Flat Rd. Exit 185A. Turn left.

Drive .2 miles to roundabout. Turn right onto Zion St.

Drive 0.5 miles on Zion St. to Reward St. Turn left on Reward St.

Drive 0.2 miles on Reward St. to St. Canice Center parking lot at end of Reward St.

Snacks, coffee and tea will be available throughout the tournament.

Sanction #1810142

2018-19 North American Pairs ACBL District 20

Win a subsidized trip to Memphis, Tenn.! Three or four pairs in each flight will earn the privilege to compete at the Spring NABC NAP Finals, March 21-31, 2019

Pre-registration is required by Oct. 13, 2018, for Flights A and C and by Oct. 14, 2018, for Flight B to assure participation in the finals.

District 20 Finals

The District 20 NAP Finals are online at various sites around the district.

Date	Event	MP limits
Saturday, Oct. 20	Flight A	unlimited
Sunday, Oct. 21	Flight B	under 2500
Saturday, Oct. 20	Flight C	NLM (< 500)



Start times: 8 a.m. in HI, 11 a.m. PDT in OR, noon MDT in Boise.

Format: All flights play two sessions with combined scoring across the field.

Venues: Playing sites are planned in Boise, Bend, Honolulu, Medford, Portland, Redding, Vancouver and other cities at clubs or at other places where participation warrants. At least two pairs and a monitor are required at each site. Contact your club, NAP Coordinator or D20 Area representative in your area for details.

Conventions: The ACBL Mid-Chart conventions may be used in Flight A and D20 allows Mid-Chart defenses to the opponents' INT openings in all events.

Awards: The finals pay gold points for overall awards and red points for sectional places.

Fees: \$60 per pair.

District Conditions of Contest: http://web2.acbl.org/NA_Events/NAP/2018/D20_NAP_CoC.pdf

National Finals

The top three or four pairs in each flight will be invited to compete in the national finals against the other district finalists. These pairs receive subsidies from both D20 and ACBL including free entry fees. The national finals will be held during the Spring NABC in March 2019 at Memphis, Tenn. Visit http://www.acbl.org/tournaments_page/nabcs/upcoming-nabcs/memphis-tn-spring-nabc-march-21-31/

NEED MORE INFORMATION?

Look on the ACBL website for additional details, including the Conditions of Contest, at <http://web2.acbl.org/documentLibrary/play/NAP/CoC.pdf>. Or, contact the district NAP Coordinator Hal Montgomery at dewitt@imaginata.com, phone (503) 583-3717.

BRONZE LIFE MASTERS

Gayanne Alexander, Corvallis OR
 Mary Bell, Canyonville OR
 Margaret Brom, Astoria OR
 Chris Copple, Eureka CA
 Phillip Frankel, McKinleyville CA
 Ginny Gainer, Portland OR
 Paul Graham, Salem OR
 Joseph Jebbia, Tigard OR
 Kathy Kuebbing, Newport OR
 Gloria Shagrun, Chico CA

SILVER LIFE MASTERS

Margot Leonard, Portland OR
 Kathryn Luft, Boise ID
 Mary Mayfield, Yuba City CA
 David McGraham, Vancouver WA
 Sherri Morgan, Eugene OR
 Anita Walker, Salem OR
 Donald Walker, Central Point OR
 Leighton Wells, Springfield OR
 Carol Williams, Kailua HI
 Cherilyn Young, Honolulu HI

RUBY LIFE MASTERS

Eileen Boal, Albany OR
 Laurie Carr, Honolulu HI
 Donald Crozier, Bend OR
 Pat Moore, Corvallis OR
 Veronica Reeves, Tigard OR
 Michael Walker, Vancouver WA

GOLD LIFE MASTER

Hon-Chung Ko, Albany OR

SAPPHIRE LIFE MASTERS

Charles Burns, Vancouver WA
 Carol Huston, Chico CA
 Laurie Rowe, Eugene OR

DIAMOND LIFE MASTERS

Alan Johnson, Happy Valley OR
 Steven Johnson, Honolulu HI
 Flo Savage, Portland OR

PLATINUM LIFE MASTER

Stu Swan, Portland OR



THE IN! CROWD

For Intermediate/Newcomer Players

Find out more about partner's hand

Sherry Squirrel is so happy to live in Portland, in close proximity to three bridge clubs. All of them celebrated The Longest Day (each on a different day so you could play in three different charity events) with multiple bridge games, earning money for Alzheimer's.

Sherry herself played in three games in one day and at the end was sure she had no brain.

Dang, today I'm either going to make up



Margi Redden
 D20 I/N Coordinator

my mind to improve or give up this crazy game. Where should I start? Do I need help with bidding? Do I need help with play? Should I work on my defense? Do I need better systems? Do I need more conventions? I can hardly remember what I am playing with whom as it is.

Today I'm going to revel in my good board; tomorrow I may decide to go over the eight disgusting bad boards. Or maybe I will invite Franny over, lure her over with a nice cabernet and discuss our boards over wine. So I pick up this lovely hand first seat.

♠KJ ♥K ♦AJ873 ♣QJ1074

I open 1♦. Next Franny bids 1♥, the opponents passing throughout. I bid 2♣, and she bids 3NT. What do I know? I think she has at least 14 HCP and I have 15 HCP and two five-card suits. I do love

those five-card suits.

So over 3NT, I bid 4NT (ace asking), she answers 5♦, which is 3 or 0 key cards, so I bid 6NT (hoping that it was 3 and not 0).

Pass, pass, double! Oops guess I was wrong. Of course she couldn't include the ♥K since I held that card.

Dlr: North ♠KJ
 Vul: None ♥K
 ♦AJ873
 ♣QJ1074

♠Q987 ♠10432
 ♥Q975 ♥10862
 ♦2 ♦Q654
 ♣K832 ♣6

The auction:

West	Sherry	East	Franny
	1♦	Pass	1♥
Pass	2♣	Pass	3NT
Pass	4NT	Pass	5♦
Pass	6NT	Pass	Pass
Dbl	All Pass		

♠A65
 ♥AJ43
 ♦K109
 ♣A95

Maybe it was zero key cards? A ♠9 is led and my partner is playing 6NT doubled! I put down my hand and apologized in advance.

Sometimes your opponents double, knowing that they're getting a bad board, praying that a double pushes Franny to be so nervous that she might misplay it. This hand is very tricky because of entries. So plan your play and see if you can make 6NT doubled with that ♠9 led.

Partner's hand:

♠A65 ♥AJ43 ♦K109 ♣A95

OK now you can see the full hand and see if you made this slam.

I asked the couple who won the event how they got to 6♦. They bid fourth suit forcing after my 2♣ bid and I rebid my clubs showing a 5-5 hand. They knew that they had two 5-3 fits. This is a double fit and they just bid 6♦. They liked all their 10s and 9s. Maybe I will invite them over for some of that cab when I can face all those red boards.

Oops, forgot to mention, my brilliant partner, Franny Fox made 6NT doubled. There was only one pair making their slam in the big dog group and they were in 6♦. We were the only pair bidding slam in our group (so maybe they were right to double).

D20 I/N Coordinator Margi Redden can be reached at d20incoord@yahoo.com.

Advice

Tricky hand, lead and double. This person is a formidable opponent. Plan your play. Play the cards where you want them to be. Fourth-suit forcing is a better bid than 3NT if you want to hear more about partner's hand. My hand has entry problems, can you solve them?

Central Oregon Coast Sectional

4 Days

October 25-28, 2018

Shilo Inn

536 S.W. Elizabeth Street
 (SOUTH END OF NEWPORT, WEST OF HWY. 101)

Reservations: (800) 222- 2244 or (541) 265- 7701

Oceanfront Rooms
 In-room microwave, coffee maker and mini-refrigerator

Website: www.shiloinns.com
 \$104 Deluxe
 or \$99 Traditional
 Pet Friendly!

Please check the website for weekly specials or ask for "American Contract Bridge League" rate!

Fabulous door prizes!

Every game!
Every day!

EVENT	THUR	FRI	SAT	SUN
Stratified Pairs (Single sessions)	7 pm	10 am 3 pm	10 am 3 pm	
Stratified 299er Pairs (Single Sessions)	7 pm	10 am 3 pm	10 am 3 pm	
Bracketed KNOCKOUTS		3 pm (Round 1)	10 am (Round 2) 3 pm (Round 3)	
Stratified Swiss Teams (Two sessions)				10 am & TBA Victory Points
299er Swiss Teams (Single Session)				10 am Win/Loss

Non-smoking sectional (breaks provided)

Fees: \$10 per session
 \$14 for lapsed ACBL members

STRATIFICATIONS

Open Events: 0-500, 500-1250, 1250+
 299er Events: 0-50, 50-150, 150-300
 KOs with only one bracket may be handicapped

Tournament Chair: Mike Rickus
 Email: mjrickus@gmail.com
 Phone: 541.574.1938

Unit 572 Website: www.unit572.org

On the road by 5 p.m.

Sanction No. 1819997

Open to all players with fewer than 300 masterpoints.
Come join in the fun and earn SILVER points!

Bob Peery

2018 Heart of the Valley

299er tournament

ACBL Limited Sectional
 November 10-11, 2018
 Heart of the Valley Bridge Center
 1931 NW Circle Blvd.
 (Corner of Circle Blvd. and Kings Blvd.)
 Corvallis, OR 97330

Saturday Nov. 10, 2018
 10 a.m. Stratified Pairs
 3 p.m. Stratified Pairs
Two separate sessions, not play-through

Sunday Nov. 11, 2018
 11 a.m..
 1-session stratified Swiss Teams
Try a team game! Just one session!

Strat A: 100 - 300 MPs Strat B: 50 - 100 MPs Strat C: 0 - 50 MPs

Check our website in October for directions and information on food and lodging: www.acbridgeclub.org.

Tournament chair:
 Rich Turnbull: 541-602-6879;
richindat@aol.com

Partnerships chair:
 Sue Fairchild: 541-752-4031;
sfairchic@comcast.net

Director: Eileen Milligan

\$9 per player per session;
 \$13 lapsed ACBL member
 ACBL Sanction No. 1811079

Rogue Valley I/N

Future Stars Sectional

For 0-99er players only!

Nov. 10-11, 2018

unit484.org

Phoenix Bridge Center
 4149 Pacific Highway S. (99),
 South of Medford
 Take exit 24 off I-5

Co-chairs:
 Gee Gee Walker
 541-292-3474
ggwalker@gmail.com

Nancy Hitchcock
 541-479-9436
jnhitchcock@charter.net

Sanction No. 1811103

Schedule
Saturday, Nov. 10
 11 a.m. Swiss teams, single session
 Complimentary lunch at mid-session break
 10:30 a.m.: Mini lesson on Swiss strategies

Sunday, Nov. 11
 11 a.m. Pairs game, single session
 Complimentary coffee and snacks

Come prospecting for some silver!
 Player Fee: \$8 per session
 \$12 for non- or lapsed members of ACBL. Temporary memberships available at venue.

THE SECTIONAL SECTION

Fall sectionals

Nevada City

The Gold Country Sectional will be held Oct. 12-14 at the St. Canice Center in Nevada City CA. See ad page 4 for details.

Vancouver NLM

The Vancouver Fall NLM Sectional will be held Oct. 13-14 at the Vancouver (WA) Bridge Club. See ad page 3 for details.

Newport

The Central Oregon Coast Sectional will be held Oct. 25-28 at the Shilo Inn in Newport OR. See ad page 5 for details.

Nampa

The Nampa-Caldwell Sectional will be held Nov. 2-4 at the Nampa Hispanic Cultural Center in Nampa ID. See ad this page for details.

Redding

The Redding Fall Sectional will be held Nov. 2-4 at the Win-River Casino in Redding CA. See ad this page for details.

Battle of the Willamette

The Battle of the Willamette Sectional will be held Nov. 3-4, with I/N events at the Ace of Clubs in Lake Oswego OR and open events at the Portland Bridge Club. See ad page 7 for details.

Corvallis 299er

The Heart of the Valley 299er Sectional will be held Nov. 10-11 at the Heart of the Valley Bridge Center in Corvallis OR. See ad page 5 for details.

Medford 99er

The Rogue Valley I/N Sectional will be held Nov. 10-11 at the Dan Voorhies Bridge Center in Phoenix OR. See ad page 5 for details.

Vancouver

The Vancouver Fall Sectional will be held Nov. 10-11 at the Washington School for the Deaf in Vancouver WA. See ad page 7 for details.

Laws: How claim issues are resolved

Continued from Page 3

might be helpful to declarer; e.g., "What about the trump I have that you forgot to draw?" Armed with this knowledge, declarer will be sure to state in his claim that his first act will be to draw the last trump. If he might otherwise have forgotten about the 13th trump, defenders may lose a trick they might have taken.

In ruling on a contested claim, the di-

rector adjudicates the result of the board as equitably as possible. However, "any doubtful point as to a claim shall be resolved against the claimer," says ACBL.

In summary, declarer should be sure she is right before making a claim, and defenders should not accept any possibly defective claim.

Dennis Kendig is a player, director and retired attorney living in Southern Oregon.

Nampa-Caldwell Harvest Sectional

Nov. 2-4, 2018

Hispanic Cultural Center of Idaho

315 Stampede Dr., Nampa, ID

208-442-0823

Exit 36 to Garrity and Stampede, directly across from the Nampa Park

Friday, Nov. 2

- Stratified Open Pairs – 1 and 6 p.m. (single sessions)
- Single Session 199ers – 1 and 6 p.m. (if attendance allows)

Saturday, Nov. 3

- Stratified Open Pairs – 10 a.m. and 4 p.m. (single sessions)
- Single Session 199ers – 10 a.m. and 4 p.m. (if attendance allows)

Sunday, Nov. 4

- Stratified Swiss Teams – 10 a.m. (2 session play-through)
(Seven 7-board matches, Victory Points)

Masterpoint ranges: A – 1500+ B – 500 to 1500 C – 0 to 500

Stratification: By average masterpoints, pairs & team games

Entry Fees:

- Friday and Saturday:
 - \$10 per person (ACBL Members)
 - \$14 per person (Non- or lapsed ACBL Members; temporary memberships available)
- Sunday - \$120 per team – **Includes lunch!**

Information:

Chairman: Anita Hansen (208) 697-9435

Co-Chairman: Duane Christensen (208) 362-6553

Partnerships: Duane Christensen (208) 362-6553

Tournament director: John Gram

SECTIONAL RESULTS

Honolulu – May (88 tables)

1	20.25	Godfrey Chang, Honolulu HI
2	18.30	Ronald Wong, Honolulu HI
3	15.91	Leo Williams, Honolulu HI
4	14.72	Mark Bennett, Honolulu HI
5	12.91	Jean Choi, Honolulu HI
6	12.41	Warren Fukushima, Pearl City HI
7	10.87	Thomas Lum, Honolulu HI
8	10.86	Vicki Sutton, Honolulu HI
9	10.66	Yasuko Shrenzel, Honolulu HI
10	10.36	Joseph Bussen, Kailua HI

Eugene (145 tables)

1	27.15	Jeffrey Taylor, Eugene OR
2	22.39	Connie Marfell, Milwaukie OR
3	21.01	Laurie Rowe, Eugene OR
4	16.99	Michael Levy, Keizer OR
5	16.06	Gerard Hallee, Hillsboro OR
6	14.33	Steven Pessin, Eugene OR
	14.33	Ginny Stark, Eugene OR
8	13.59	Don Lowry, Wilsonville OR
9	10.85	Jon Bartlett, Portland OR
10	10.79	Cynthia Palman, Eugene OR
11	10.11	Sandy Syrett, Corvallis OR
12	9.86	Lynne Schaeffer, Portland OR
	9.86	Alan Johnson, Happy Valley OR
14	9.14	Louis Beauchet, Sherwood OR
15	8.48	Glenda Fleming, Albany OR

Portland (149 tables)

1	28.06	John Ashton, Portland OR
	28.06	Dennis Metcalf, Vancouver WA
3	19.94	Jon Bartlett, Portland OR
4	16.22	David Brower, Portland OR
5	15.00	Hal Montgomery, Portland OR
6	12.38	Raj Garg, Portland OR
7	11.73	Jay Kurzet, Portland OR
8	11.54	Jean Johansson, Portland OR
9	11.42	Richard Soohoo, Vancouver WA
10	11.29	Gerard Hallee, Hillsboro OR
	11.29	Alan Johnson, Happy Valley OR
12	9.87	Roger McNay, Beaverton OR

13	9.14	Nancy Jonske, Portland OR
14	8.86	Amy Casanova, Portland OR
15	7.74	Robert Johnson, Tigard OR
	7.74	Lisa Fishman, Beaverton OR

Salem (142 tables)

1	18.50	Richard Soohoo, Vancouver WA
2	16.60	Daniel Hoekstra, Portland OR
3	15.10	Alan Johnson, Happy Valley OR
4	14.65	Connie Coquillette, Vancouver WA
5	13.96	Don Lowry, Wilsonville OR
6	13.81	Amy Casanova, Portland OR
7	13.22	Louis Beauchet, Sherwood OR
8	13.20	Hal Montgomery, Portland OR
9	13.17	Kevin Kacmarynski, Monmouth OR
10	12.92	Gerard Hallee, Hillsboro OR
11	12.65	Michael Levy, Keizer OR
12	12.58	Robert Law, Tigard OR
13	12.53	Samuel Asai, Hood River OR
14	12.48	Jon Bartlett, Portland OR
	12.48	John Ashton, Portland OR

Honolulu – July (99 tables)

1	28.65	Mark Bennett, Honolulu HI
2	23.86	Godfrey Chang, Honolulu HI
3	14.32	Everett Fukushima, Aiea HI
4	12.57	Penny Kallaus, Honolulu HI
5	12.32	Robert Liu, Honolulu HI
6	10.72	Alan Kosansky, Kailua HI
7	10.58	Ronald Resnick, Kula HI
8	10.20	Margaret Cooling, Honolulu HI
9	10.00	Ronald Wong, Honolulu HI
10	9.86	Iku Donnelly, Honolulu HI

Portland I/N Sectional (45 tables)

1	6.31	Stuart Director, Portland OR
	6.31	Nely Johnson, Portland OR
3	3.96	Dan Edelstein, Vancouver WA
	3.96	Andrew Nuxoll, Portland OR
5	3.90	Joanne Ruyle, Portland OR
6	3.61	Judith Wilkinson, Portland OR

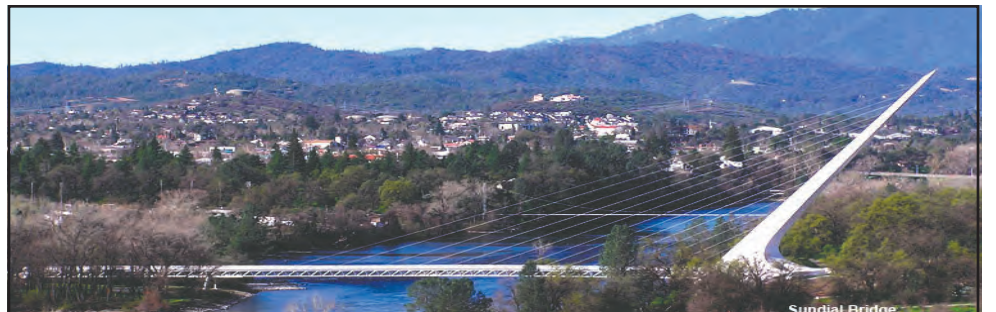

Redding Unit 464 Presents

The Sundial Bridge Sectional

Nov. 2-4, 2018

Win-River Resort & Casino • 2100 Redding Rancheria Rd. • Redding, Calif.

Ask for bridge tournament rate: Thurs., 11/1, \$99;

Fri. and Sat., 11/2 & 11/3, \$109; Sun., 11/4, \$99 (deadline is Oct. 19)

530-243-3377 or 800-280-UWIN; www.winriver.com

\$5 free slot play added to NEW Win-River Players Club cards

Friday, Nov. 2

299er Pairs (3 tables minimum)	10 a.m.	3 p.m.
Open Pairs (single sessions)	10 a.m.	3 p.m.

Saturday, Nov. 3

299er Pairs (3 tables minimum)	10 a.m.	3 p.m.
Open Pairs (two session event)	10 a.m.	3 p.m.

(Single session pairs welcome)

Sunday, Nov. 4

Stratified Swiss Team (20 Victory Point scale)	10 a.m.
--	---------

Two sessions play through

(Lunch will be available between sessions)

Per-session fee of \$10 per player • \$5 extra for lapsed ACBL members

This is a Z-T policy event

Stratifications

A: 2000+
B: 750-2000
C: 0-750 (NLM)
299ers: 0-300

Director:

Steve Kaessner

Chairperson:

Gerald Clark, 530-357-2694

Partnerships:

Wilhelmina White, 530-246-1036



Play of the Hand

Extra time spent thinking on opening lead pays off

After four years plumbing popular bidding conventions in *The Bidding Toolbox*, Trumpet columnist Jim Flint shifts to a new focus with *Play of the Hand*.



Jim Flint
Play of the Hand

Dlr: North ♠K 8 6 5
Vul: E-W ♥J 9 6 5
♦K
♣10 8 4 2

♠A 10 9 7 2 ♠Q J 3
♥K 10 ♥8 4
♦9 5 4 ♦A Q 7 6 3 2
♣Q 7 5 ♣K 3

♠4
♥A Q 7 3 2
♦J 10 8
♣A J 9 6

West	North	East	South
	Pass	1♦	1♥
1♠	2♥	2♠	Pass
Pass	3♥	Pass	Pass
3♠	All Pass		

West. If South continues hearts, West wins with the king and leads to the ♠K, to cut communication between East and West, afraid of diamond ruffs.

Then when West pulls trumps, it doesn't do North any good to lead his singleton diamond after he takes his ♠K. West lets it hold to preserve his entry to the diamonds. Now North can't get to South for a diamond ruff.

If South switches to a diamond on the second trick, it's too late. West can bring the contract home, losing a spade, a diamond ruff, a heart and a club.

North, however, had second thoughts about his opening lead. East-West didn't bid game, so South might have two entries. If so, North could lead his singleton king, likely dead anyway, and hope for two diamond ruffs after he gets in with the ♠K.

He plunked down the ♦K, taken by the ace. West should just cash the ♠A and lead another one, hoping for a 3-2 break in trumps. He can afford one diamond ruff but not two.

Here, when North takes his ♠K, he leads a heart to his partner for a diamond ruff. Then, since South took the heart with the ace, denying the king, North tries a club back, which works, and he gets a second diamond ruff. Down one, for the top score.

Count to 10 before you make the opening lead. Sometimes thinking outside the box pays off.

You can reach Jim Flint at pubathome@yahoo.com

This competitive auction in a club game resulted in the side with the boss suit prevailing. In the bidding, that is.

North considered bidding on, hoping for a good matchpoint score at down one if West can make 3♠. But he liked his defensive chances with four spades to the king, so passed.

What should North lead against 3♠? Should he lead a heart to make sure his side gets its heart tricks before they're sluffed on good diamonds?

If he leads a heart, it's smooth sailing for

Teachers' Corner

ACBL revamps teacher certification workshop

The ACBL has replaced its old Teacher Accreditation Program for a new, revamped Best Practices Teacher Workshop. I attended the new program at the Atlanta NABC to see what it was about.

Weeks before the course, a test covering basic bridge knowledge was sent out. If the test was not passed with a 70% score, would-be students were not allowed to take the workshop. The three-day seminar was a fast-paced, highly interactive process relying on teachers learning from their interactions and experiences. The facilitator's objective was not to speak for more than five to seven minutes at a time.

The workshop emphasizes giving students more hands-on activities, not putting any student on the spot, encouraging students and allowing them to make mistakes as part of their learning.

Several demonstrations on teaching methods were included in the workshop. At the end, participants could sign up for an assessment where a 12-minute lesson is taught, demonstrating proficiency. Unlike other accreditation programs, a teacher does not earn a Best Practices accreditation unless the BP Teacher evaluation is passed.

After passing the assessment, teachers receive a certificate, special pin, access to special templates and logos, as well as being listed in the ACBL Teacher Directory as a Best Practices Teacher. The ACBL has a schedule on its website of future workshops to be offered.

Seagram seminar

Barbara Seagram presented a three-day seminar to a packed room at the Great Potato Regional in Boise. Her presentations were lively, full of humor and most of all, full of tips that we could all use immediately at the bridge table.

Fresh out of the Best Practices Workshop, I particularly noticed Seagram's extremely effective teaching style modeled the workshop's advice. Her lecture time was very limited, there were lots of hands-on activities, students were allowed to make mistakes and no one was made to feel embarrassed or put on the spot. My favorite piece of advice she gave to the newer players was, "If you play only once a week, you will be a weak player."

Her husband, Alex Kornel, accompanied her during this trip. They played all week and were available to players seeking assistance on difficult hands they had encountered.

Jonske new liaison

Nancy Jonske will be the new education liaison for District 20. Her passion is teaching bridge to middle school students. Nancy has a great deal of enthusiasm and passion for the game of bridge.

The district is very fortunate she has agreed to take this role. Please join me in welcoming her and wishing her much success.

Deborah Lackey can be reached at Deborah@DeborahLackey.com.



Deborah Lackey
D20 Education Liaison

Nov. 3-4, 2018

UNIT 487 SPONSORS

Sanction No. 1811109 Sanction No. 1811110

The West
Willamette Sectional

West Location:
Ace of Clubs
Mountain Park Plaza
11830 SW Kerr Parkway,
Lake Oswego, OR 97035
(503) 646-8252

Schedule:
Sat. Nov. 3, 10:30 a.m.

- Non-LM Pairs Pairs, Stratified
This is the Non-LM "Battle of the Willamette" (single sessions)
- 0-100 pairs (play separately if # of tables permit)
Sat. Nov. 3, 3:30 p.m.
- Non-LM Pairs Pairs (0-500), Stratified
Sun. Nov. 4, 10:30 a.m.
- Non-LM Swiss Teams (0-500) single session, stratified, win/loss

West
Tournament Chair: Alan Johnson,
apeace01@comcast.net
Partnership: Nancy Swanson, nswanson@gmail.com

The East
Willamette Sectional

East Location:
Portland Bridge Center
2010 Lloyd Center
Portland, OR 97232
(503) 252-1318

Schedule:
Sat. Nov. 3
10:30 a.m. and 3:30 p.m.

- Open Pairs stratified, single sessions (0-750, 750-2000, 2000+)

Sun. Nov. 4
10:30 a.m. and TBD

- Swiss Teams 2 sessions, stratified, VPs

East
Tournament Chair: Alan Johnson,
apeace01@comcast.net
Partnerships: Ron Root,
ronaldroot@comcast.net

Both tournaments

- \$10 per session (\$15 for lapsed ACBL members; temp memberships available)
- \$5 students under age 26 with student ID (\$10 if nonmember)

Vancouver USA

Fall Sectional

November 10-11, 2018

Join us at the
Washington School for the Deaf,
611 Grand Blvd. (entrance on Evergreen Blvd.)
Vancouver, Wash.

Saturday, Nov. 10 – Pairs

Stratiflighted Open Pairs (AXY & BCD)..... 10 a.m.
Novice Pairs (0-100 stratified, # of tables permitting)..... 10 a.m.
Stratified Open Pairs..... 3 p.m.
NLM Pairs (0-500 stratified)..... 3 p.m.

Sunday, Nov. 11 – Teams

Stratiflighted Swiss Teams 10 a.m. & TBA
Flight A = 5000+; X = 3000-5000; Y = 0-3000
Flight BCD: B = 750-2000 C = 300-750; D = 0-300
*Stratified Fast Pairs (single session) 10 a.m.
*Field stratified by director based on entries
Schedule is subject to change

OPEN STRATS	NLM STRATS	STRATIFLIGHTED PAIRS	
A = 2000+	A = 300 - 500	A = 4000+	B = 750 - 1500
B = 1000 - 2000	B = 100 - 300	X = 2500 - 4000	C = 300 - 750
C = 0 - 1000	C = 0 - 100	Y = 0 - 2500	D = 0 - 300

A team with any player over 2000 plays in Flight A/X/Y
Strats for all events are based on average masterpoints of team or pair

Fees: \$10/session; \$14/session for lapsed ACBL members; non-ACBL members will be required to join. Temporary memberships available.
Players with 0-5 masterpoints play free!

Head Director: Jeff Jacob
Tournament Manager: Mariam Saner, 858-603-0050, mariamsaner@me.com
Partnership Desk: Barbara Pyles, 971-275-4508, barbarapyles@gmail.com

Sanction #: 1811035

ATLANTA SUMMER NABC

District 20 Flight C team reaches GNT semifinal

By Kevin Marnell and Jon Gassaway
For The Trumpet

The District 20 Flight C team made it to the semifinals in the 2018 Summer NABC Grand National Teams in Atlanta, losing a close match in the final boards.

The team included **Dan Edelstein – Andrew Nuxoll, Roger Thomas – Jon Gassaway and Frank Straulemann – Kevin Marnell.**

This was District 20's best finish in the GNT Flight C since 2010, when a C team reached the final.

A Flight B team did the same in 2014, and last year D20's Championship flight team reached the semifinal. It has been more than 10 years since a D20 team won any flight.

Qualifying Swiss

During the run-up, there were some very interesting hands. In the qualifying Swiss, Roger and Jon reached a doubled slam on the following hand with both sides not vulnerable.

Sitting West, Jon held:

♠J ♥— ♦9 8 7 6 5 4 ♣K J 10 9 8 7.

And the bidding went:

West Gassaway	North	East Thomas	South
	1♠	2♠	Dbl
2NT	Pass	3♦	3♠
5♦	5♠	Dbl	Pass
6♦	Dbl	All Pass	

Once Roger bid Michaels, showing hearts and an undisclosed minor, Jon wanted to bid up to the five level in their minor-suit fit. He bid 2NT to ask for Roger's minor.

Jon felt that with his minimal defensive prospects the opponents appeared to be headed for game or slam in spades. Non-vulnerable, Roger could have a very weak

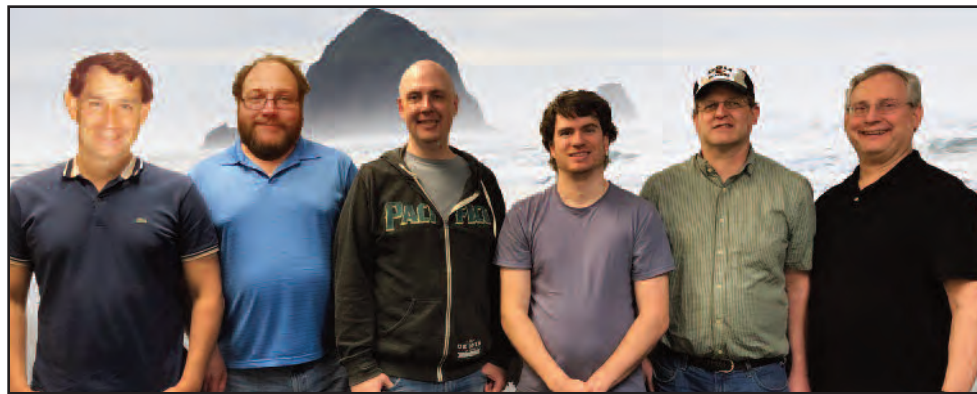

Dan Edelstein, Andrew Nuxoll, Kevin Marnell, Frank Straulemann, Jon Gassaway, Roger Thomas

hand, and this bid may keep the opponents out of six.

However, when the opponents competed to 5♠ and Roger doubled, Jon recognized Roger's Michaels bid was made with a strong hand.

"My partner is usually right when he doubles for penalty, and his double told me that he had a relatively strong Michaels hand," Jon said. "If he is counting on me for defensive tricks, he will be underwhelmed. It seemed like we would score better at IMPs on the range of hands that he might have."

Having a hand built for offense, Jon bid the 6♦ slam, which the opponents doubled. The opponents led the ♥A, and Roger declared, holding:

♠A 4 ♥Q 8 6 4 3 ♦A Q J 10 3 ♣A

Roger ruffed the opening lead, and was able to make 13 tricks after the ♦K fell under his ace. Though 4♠ can go down as much as three, at the other table it was allowed to make, so this was worth 17 IMPs.

Knockout phase

We finished the Swiss in sixth place and were shuffled to receive the 7 seed. In the first round of the knockout phase, we faced a team from District 22 in Southern

California that featured several young players — Emma and Finn Kolesnik and Jake and Luke Williams. Later at the Atlanta NABC, Emma and Jake's team from Harvey Mudd College placed third in the Collegiate Bridge Bowl, while their younger siblings won the National Youth Swiss Teams.

Our match with them was close, tied at the first quarter and them leading by 3 at halftime. We went on to win by 30.

Quarterfinal

That brought us to a quarterfinal match against a team from the Detroit area in District 12.

Frank and I sat against this year's Flight C North American Pairs pair winners, Henry Zhang and Yanping Zhang, who finished just ahead of our teammates Roger and Jon. We were both playing strong club systems, which led to a great number of IMPs being thrown back and forth every round.

In the last board of the match they bid up to an aggressive 4♥, leaving Frank and me on the hook to defeat this contract.

(see next column)

Frank led the ♣K, to which I played an approving spot and declarer ruffed.

♠ A J 10 9 4 3
♥ 5
♦ 10
♣ 9 7 6 5 4

Frank

♠ 6 5 2
♥ 8 6
♦ 9 7 6 5
♣ K Q J 2

Kevin

♠ Q 8 7
♥ Q J 9
♦ A K 3
♣ A 10 8 3

♠ K

♥ A K 10 7 4 3 2
♦ Q J 8 4 2
♣ —

Declarer first played his ♠K, and then led to his ♦10 in dummy. I won my king and returned the ♥J to prevent him from trumping a diamond.

Declarer took his two top trumps, and then led a trump to my queen. Declarer's play of the ♠K looked suspicious. Whether singleton or not, declarer almost certainly had diamond length, and Frank might have a late diamond winner. The spades did not look like an immediate threat in any case, so I led a low club.

Having already lost a heart and a diamond, declarer had to play diamonds out of his own hand, which gave us two more diamonds, setting the contract.

By that point, though, we were up handily, winning 171-136.

Semifinal

This advanced us to the semifinal round, where we faced a team from neighboring District 19. The match was never out of reach, and we led in the first quarter. After taking a 10-IMP lead at halftime, they held onto it after a tied third quarter. It remained close but near the end of the fourth quarter it slipped away from us, and the final score was 135-111.

Our semifinal opponents went on to lose in the final to the District 23 team from Los Angeles.

Navigating BBO – part 3: alerts

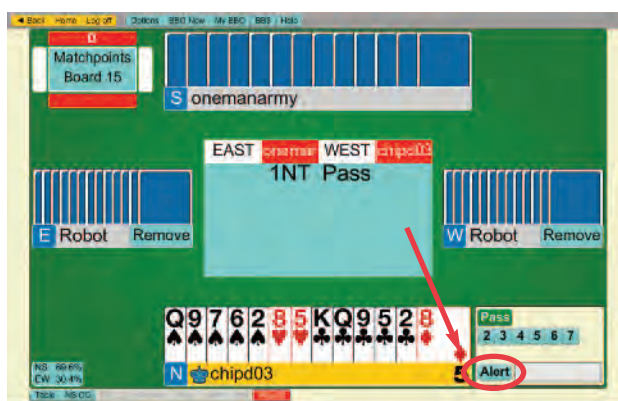

1 It's your turn to bid, and you realize the bid you're about to make requires an alert. In this case, partner has opened 1NT and you want to transfer. Before doing anything else, click the alert button.

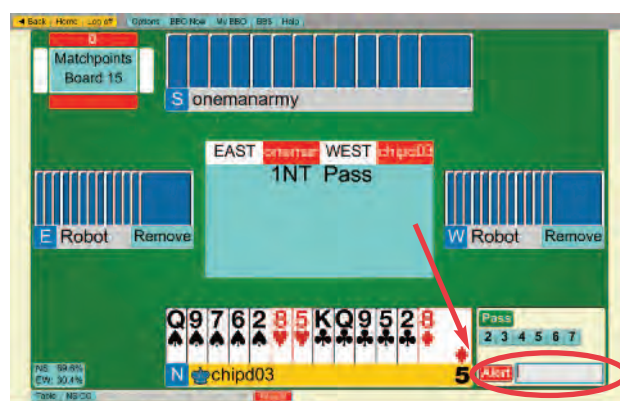

2 The alert button will turn red and a cursor will appear. Type an explanation for your bid here.

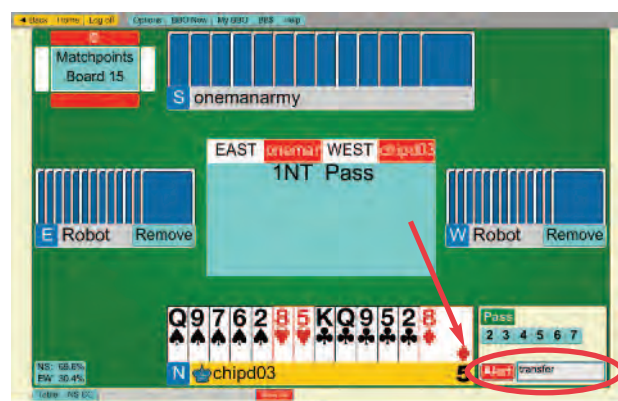

3 After you have entered your alert and explanation, you are ready to select your bid. Once you bid, it's too late to alert. Select the level of your bid.

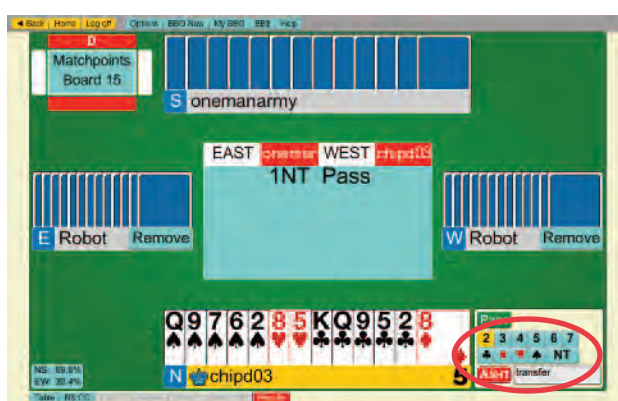

4 Once you select a level, the strains appear. Select the appropriate strain. In this case we want to bid 2♥ to transfer to spades.

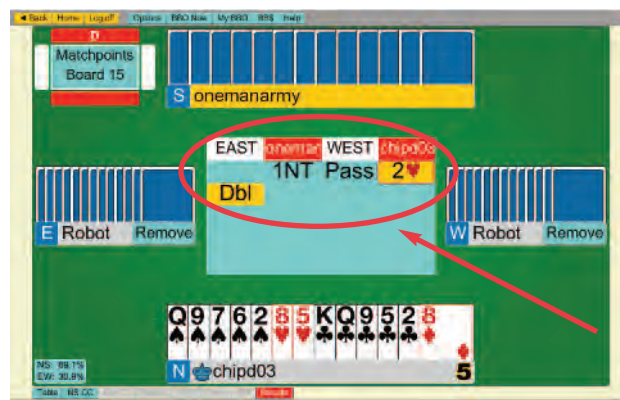

5 When you click the suit symbol, your bid appears in the auction diagram highlighted in yellow and outlined in red. The auction continues. Note that although partner alerted his 1NT bid as 15-17, you don't see his alert and he can't see yours.



6 During or after the auction, you can hover over any bid highlighted in yellow to see the explanation. If there is a red outline but no yellow, you can click the bid to prompt the person who made the alert to fill in the explanation.

The Oregon Coast Regional *at Seaside*

SCHEDULE

MONDAY October 1

7 p.m.Seaside Bracketed KOs
(winners continue at 9, 1 & 7 on Tues.)
7 p.m.Stratified Charity Swiss Teams
7 p.m.Stratified Open Charity Pairs
(part of Evening Side Game Series) (1 of 6)
7 p.m.♦ 299er Stratified Charity Pairs

TUESDAY October 2

9 a.m.Morning Side Game Series (1 of 5)
9 a.m.♦ 299er Stratified Pairs
1 p.m.Gearhart Bracketed KOs
(winners continue at 7; and at 1 & 7 on Wed.)
1 & 7 p.m.Three Strat Open Pairs
1 & 7 p.m.♦ **Razor Clam Gold Pairs**
1 p.m.Afternoon Side Game Series (1 of 5)
1 p.m.♦ 299er Stratified Pairs
1 p.m.♦ 99er Stratified Pairs
7 p.m.Stratified Swiss Teams
7 p.m.Evening Side Game Series (2 of 6)
7 p.m.♦ 299er Stratified Pairs

WEDNESDAY October 3

9 a.m.Morning Stratified Swiss Teams
(continues at 9 on Thur.)
9 a.m.Morning Side Game Series (2 of 5)
9 a.m.♦ 299er Stratified Pairs
1 p.m.Astoria Bracketed KOs
(winners continue at 7; and at 1 & 7 on Thur.)
1 & 7 p.m.Two Strat Open Pairs
1 & 7 p.m.Mid-Flight Pairs (Under 2000)
1 & 7 p.m.♦ **Coho Gold Pairs**
1 p.m.Afternoon Side Game Series (2 of 5)
1 p.m.♦ 299er Stratified Pairs
1 p.m.♦ 99er Stratified Pairs
7 p.m.Stratified Swiss Teams
7 p.m.Evening Side Game Series (3 of 6)
7 p.m.♦ 299er Stratified Pairs

THURSDAY October 4

9 a.m.Morning Side Game Series (3 of 5)
9 a.m.♦ 299er Stratified Pairs
1 p.m.Lewis and Clark Bracketed KOs
(winners continue at 7; and at 1 & 7 on Fri.)
1 & 7 p.m.Two Strat Open Pairs
1 & 7 p.m.Mid-Flight Pairs (Under 2000)
1 & 7 p.m.♦ **Chinook Gold Pairs**
(Thursday continues - see next column)

THURSDAY October 4 (continued)

1 p.m.Afternoon Side Game Series (3 of 5)
1 p.m.♦ 299er Stratified Pairs
1 p.m.♦ 99er Stratified Pairs
7 p.m.Stratified Swiss Teams
7 p.m.Evening Side Game Series (4 of 6)
7 p.m.♦ 299er Stratified Pairs

FRIDAY October 5

9 a.m.Morning Stratified Swiss Teams
(continues at 9 on Sat.)
9 a.m.Morning Side Game Series (4 of 5)
9 a.m.♦ 299er Stratified Pairs
1 p.m.Sand Dollar Bracketed KOs
(winners continue at 7; and at 1 & 7 on Sat.)
1 & 7 p.m.Three Strat Open Pairs
1 & 7 p.m.♦ **Oyster Gold Pairs**
1 p.m.Afternoon Side Game Series (4 of 5)
1 p.m.♦ 299er Stratified Pairs
1 p.m.♦ 99er Stratified Pairs
7 p.m.Stratified Swiss Teams
7 p.m.Evening Side Game Series (5 of 6)
7 p.m.♦ 299er Stratified Pairs

SATURDAY October 6

9 a.m.Morning Side Game Series (5 of 5)
9 a.m.♦ 299er Stratified Pairs
1 p.m.Jellyfish Compact KOs
(winners continue at 7)
1 & 7 p.m.Three Strat Open Pairs
1 & 7 p.m.♦ **Steelhead Gold Pairs**
1 p.m.Afternoon Side Game Series (5 of 5)
1 p.m.♦ 299er Stratified Pairs
1 p.m.♦ 99er Stratified Pairs
7 p.m.Stratified Swiss Teams
7 p.m.Evening Side Game Series (6 of 6)
7 p.m.♦ 299er Stratified Pairs

SUNDAY October 7

10 a.m. & TBA ...Strati-Flighted A/X/Y Swiss Teams
10 a.m. & TBA*Bracketed Flight B Swiss Teams
10 a.m. & 1 p.m.Stratified Fast Pairs

♦ *Lowest brackets will include 299er and 0-750 teams. Gold points in every bracket!

October 1-7, 2018

Seaside Convention Center
415 1st Ave., Seaside, OR

INTERMEDIATE/NEWCOMER PROGRAMS

- ♦ Saturday prize games.
- ♦ Between session party.
- ♦ Tips for Tops: Daily speakers 6:15 p.m.
- ♦ Mini-Classes: Wed. - Sat., 12 - 12:30 p.m.
- ♦ Morning 299er Pairs Tues. - Sat.
- ♦ Afternoon 299er Pairs Tues. - Sat.
- ♦ Evening 299er Pairs Mon. - Sat.
- ♦ Afternoon 99er Pairs Tues. - Sat.
- ♦ Gold Pairs daily Tues. - Sat.
- ♦ Gold point opportunity on Sunday in the lower brackets of the 2-session Bracketed Flight B Swiss Teams.
- ♦ Prize beads.

D20 I/N Coordinator:

Margi Redden, cell 503-805-2103.

D20INCoord@yahoo.com

YOUR HOSTS

DIRECTOR IN CHARGE: Matt Koltnow

D20 TOURNAMENT MANAGER

Jim Wheeler, 503-860-0563

jimpamw@yahoo.com

LOCAL CHAIRS

Gil and Ann Gramson,

503-861-1133

gilandanngramson@charter.net

PARTNERSHIPS:

Sue Kroning

503-738-7817; cell 503-739-0264

skroning@centurylink.net

CADDY CHAIR: Sandra Baker

HOSPITALITY CHAIR: Jan Amend

STRATIFICATIONS

Stratified Open Events:

A: 2000+; B: 750-2000; C: 0-750

Three Strat Open Pairs:

A: 3000+; B: 1500-3000; C: 0-1500

Two Strat Open Pairs:

A: 3000+; B: 0-3000

Mid-Flight Pairs (Under 2000):

A: 1250-2000; B: 0-1250

Gold Pairs (Under 750):

A: 300-750; B: 200-300; C: 0-200

♦ 299er Events (Under 300):

A: 200-300; B: 100-200; C: 0-100

♦ 99er Events (Under 100):

A: 50-100; B: 20-50; C: 0-20

Strati-Flighted A/X/Y Swiss Teams:

A: 4000+; X: 2500-4000; Y: 0-2500

(plays alone; 20 VP).

Bracketed Flight B Swiss Teams:

0-2000 (no player over 2000); teams play in groups of 7-9 by MP average; gold points in each bracket; (20 VP).

SCHEDULE NOTES

- Eligibility for flighted events based on top player's MP total. Thereafter, strats determined by average of pair or team.
- Midchart conventions allowed in Sunday Flight A/X/Y Swiss, Two Strat Open Pairs, and top bracket of KOs (except compact). Midchart defenses to opponents' 1NT openings are allowed in all events.
- One bracket KO may be handicapped.
- Play 2 times in side game series to qualify for overall gold points.
- ♦ Indicates Intermediate/Newcomer events.
- TABLE FEES:** ACBL members \$12; lapsed ACBL members \$16; under age 26, \$5. Temporary memberships available at venue.

ACCOMMODATIONS

- **THE INN AT SEASIDE:** Across the street; free breakfast; \$99-\$119; 1-800-699-5070.
- **RIVER INN AT SEASIDE:** Riverfront; 1 block; 503-717-5744; \$109-\$129.
- **RIVERTIDES SUITES:** Riverfront condo hotel; ½ block; free breakfast & evening reception; call hotel for rates. 1-877-871-8433.
- **SHILO OCEANFRONT RESORT:** Oceanfront; 2 blocks; \$98-\$185; 800-222-2244 or 503-738-9571. Cutoff date: 9/10/2018.
- **SHILO EAST:** ½ mile; continental breakfast; 503-738-0549. Call for rates.
- **BEST WESTERN OCEANVIEW RESORT:** Oceanfront; 4 blocks; 1-800-234-8439. Call for rates.
- **HOLIDAY INN EXPRESS:** Riverfront; ½ block; free breakfast; 503-717-8000. Call for rates.
- **OTHER CHOICES:** Seaside has many charming small hotels, bed & breakfasts, condos and houses to rent. www.SeasideOR.com.

Till bridge do us part: These 10 Pacific Northwest couples prove it's possible to mix marriage with bridge partnership and come out ahead in life and at the bridge table



Ron Jauch & Jamie Newman
Their goal: leave the table as friends

By Jen Smith

From Nevada City, Calif., Ron Jauch and Jamie Newman have been playing together as husband and wife since 2002 — a time when Ron was a more experienced player than Jamie.

"I barely had over 500 points and Ron had almost 1700," Jamie said. "I not only didn't have a huge interest in bridge, but I had no clue that the game was such a wonderful game. Ron enhanced my bridge skills for sure." Though the point gap remains, she now has over 4000 and Ron is a Diamond Life Master.

In those early years there were occasional tense moments. Jamie says they still disagree despite years of playing as partners, but their goal is to always leave the table as friends. And if it gets re-

ally tense, according to Jamie, listening to books on tape helps ease a long drive home.

So what about the good times? For this couple, they agree that playing as a couple affords them the opportunity to travel to cities they've always wanted to visit while also participating in bridge tournaments.

"In those cities, we walk and walk and walk and play too many bridge sessions simply because we can't help ourselves," Jamie said.

In terms of advice they would give to couples who are just starting out as partners, Jamie offers this: "Try to save any remarks until the end of a session. Try not to show negative emotion at the table. Talk about the hands after the session. Leave the table as friends."

Ron's advice is to focus on the game and not let mistakes become personal and distracting for your relationship.



Bob & Jill Wolcott
50 years of bridge and still speaking

By Jim Flint

Rogue Valley residents Bob and Jill Wolcott met playing dorm bridge in 1967 at Chapman College in Orange, Calif.

The fact that they recently celebrated their 50th wedding anniversary says something about the cordiality of their game.

Bob said he can be a bit of a wild hare in the bidding while Jill is the more conservative one. What happens when he goes nuts on a hand?

"I say, I'm sorry," Bob chimed. "And I say, good!" Jill grinned.

"Sure, we've had some long quiet trips home in the car after a tough game," he said. "But life is more than just about bridge."

They both said they're each other's favorite partner.

If there's a big dust-up after a bridge disaster, isn't the makeup sex worth it?

"The what?" Bob laughed. Jill giggled.

Long-time 299er players, they've been playing in the open games more often these days. One of the big highlights was coming in first in a StaC event. As they continue to improve their game, there surely will be more highlights to follow.



Pat & Polly Dunn
Successful bridge is a Dunn deal

By Chip Dombrowski

Pat and Polly Dunn have had a lot of success at the bridge table.

The Bellevue, Wash., couple is among the strongest pairs in the Northwest. They became Grand Life Masters in 2011 when they won the Senior Mixed Pairs at the Fall NABC in Seattle, their home turf. Pat has 22,000 masterpoints and Polly 16,000. Though they live in District 19, they almost never miss a District 20 regional.

They learned bridge separately while in college during the 1960s and began playing together in 1994, by which time each had several decades of tournament experience and had on occasion been opponents.

Both played 2/1, so they found it relatively easy to form a partnership. Polly, the more flexible partner, largely adopted Pat's convention card. They play together most of the time at regionals and nationals and sometimes with other people at local sectionals and occasional club games.

"There is no 'silver bullet' that guarantees a partnership's success or longevity," Polly said. "We are

fortunate that while problems arise and disagreements occur, (they) do not become internalized into our personal interactions. This is easier said than done, obviously."

To make it work, the Duns each recognize the contributions and efforts of the other, and that each is trying to maximize the success of the partnership. They sometimes discuss bridge hands and theory at home, but mostly during tournaments.

"We tend not to try to 'hit a lot of home runs,'" Pat said. "In other words, our approach is to attempt to bid and play solidly, earning our good results and capitalizing on the opponents' errors."

Both have had moderately high finishes in other national events, including Polly's taking second place in the 2005 Whitehead Women's Pairs. But winning a national championship together was particularly meaningful, they said. They recall the final as a series of good decisions and fortunate breaks on key hands.

"The game remains a constant source of challenge, with frustration at our failures and pleasure at our successes," Polly said. "Duplicate bridge has been a wonderful activity for us."



Barry & Lucy Sorenson
Humor keeps it light and fun

By Chip Dombrowski

It was the year Lyndon Johnson announced the creation of Medicare, when the "Sound of Music" was released, and when the miniskirt was introduced.

The year 1965 was also when Barry and Lucy Sorenson of North Bend, Ore., got married and started learning bridge together. They have run Bay Area Bridge Club in North Bend since 2005. They play a lot of duplicate bridge — three or four tournaments a year and three club games a week, two together and one with other partners.

They have played bridge for 53 years, but began playing duplicate in the 1990s.

"What makes us fairly compatible is we're more or less equally experienced," Barry said.

Lucy, a Ruby Life Master, leads Barry by 150 masterpoints, mostly from the three and a half years she played duplicate before he started.

Humor is key to their partnership. Once asked if a bid by Barry was forcing, Lucy joked, "Nothing he does is forcing."

She also has been known to pull out a pass card that has been changed to say "I want a divorce," to make light of finding herself in what she expects to be a bad contract.

They laugh at themselves and keep their opponents laughing too, regardless of who comes away with the better scores. As Barry says, "It makes it more fun for the people at the table anyway."



Jim & Carol Reed
It was not quite 'play bridge or else'

By Jen Smith

When Jim Reed told his future wife, Carol, that if she wanted their relationship to grow, she'd need to learn how to play bridge, she did just that, to his surprise.

"We have been married for 44 years and bridge still remains our favorite joint activity," Jim said. "Even when we stopped playing duplicate for a number of years, we continued to discuss bridge hands daily and played family party bridge whenever we had four players together."

Carol echoes Jim's comments, saying bridge has helped their marriage because "we are happy to be together for such long continuous periods of time during the game."

Their words of wisdom? From Carol: "Be forgiving; remember you love this person; and remember everyone makes mistakes."

From Jim: "Whenever your partner makes a mistake, determine whether it is a misunderstanding or just a silly error. Never comment on silly errors." Words to live by.



Tom & Suzy Ryder
Playing with his favorite person

By Jen Smith

Tom and Suzy Ryder from Boise, Idaho, have been playing bridge together for more than 40 years. Tom said he's never had another regular partner.

In those 40 years, it's no surprise that a tense moment or two might pop up along the way. And for this couple, there's one Tom won't even talk about. "Suzy didn't play with me for months and months. Completely my fault and a

very, very embarrassing moment for which I am terribly sorry," Tom said.

Asked what happened, Suzy simply replied, "When he threw his cards on the table, cursed, and stomped away."

The two have enjoyed years of great moments. According to Tom, the best moment in playing with Suzy is "every day when we open our first hand. Win or lose. I am enjoying every day with my favorite person," he beamed.

Like most couples, the pair says the best advice is to save discussions for after the game.



Marc Franklin & Mary Lou Moriarty
Met at bridge, now partners in life

By Jim Flint

Some couples thrive despite playing bridge together. But for Mary Lou Moriarty and Marc Franklin of Portland, who met over the bridge table nine years ago, the game was a spark of their romance. And they've been a couple ever since.

"Marc is my favorite partner," said Moriarty. "He loves gadgets and is a gentleman at the table." What's not to like about that? "My strength is declarer play," Franklin said, "but Mary Lou has a great sense of the table." There was pride in his voice when he complimented her.

Franklin, 86, is a retired Stanford University law professor. Moriarty, 79, raised five children and worked in radio for a time, writing copy and managing schedules.

Both have played duplicate for many years. Franklin has nearly 2500 masterpoints, with Moriarty only a couple hundred behind him.

The two like to play mostly pairs these days. "For me, it used to be teams that I wanted to play at tournaments, on the grounds that at clubs, it was all pairs," Franklin said. "But these days, we usually play pairs."

Moriarty said she always preferred pairs. "The thing about teams is that when you make a mistake, you not only hurt yourself and your partner, you hurt your teammates," she said.

Moriarty said the first time she met Franklin was when he needed a partner at a club where she played.

"Being the professor he was, the first thing he said we needed to do was fill out a card. With all his gadgets, it was all I could do to manage the red and black pencils," she said, laughing.

They both enjoy traveling and combine it with bridge often, going to an occasional regional or NABC. They've taken a Larry Cohen bridge cruise and plan another one soon.

They play a 2/1 system, and Franklin likes to utilize losing trick count theory in his bidding.

They have their good games and their bad, like all pairs. "Sometimes you make a big mistake and, as we like to say, go for a telephone number (a big set)," Moriarty said. "But we talk it over afterward, going over the hands, and never second guess each other."

Franklin said he's definitely one who waits until after the game to discuss foul-ups. "Never at the table," he said.



Larry & Laura Smith
Try listening instead of fighting

By Jen Smith

Larry and Laura Smith are from Redmond, Ore. They met in 1980 and have been playing bridge together ever since. Larry actually taught Laura how to play the game all those years ago.

Larry can't pinpoint a particular tense moment at the bridge table, but Laura recalled a time when Larry passed a Texas transfer bid and she played a 4♥ contract in a 3-1 fit. "When I made the bid, he paused to think, and finally passed," Laura said.

Larry said most of their tense moments have taken place away from the bridge table, whenever he and Laura discuss hands.

"Many times in the early years, she felt like I was picking on her when I was just trying to explain my reasoning for what I thought should have happened."

Larry said he doesn't consider any of their disagreements as fights. "Any continuation of the discussion at home is trying to reach an agreement, which doesn't always

happen," he said. "Most of our disagreements are about failure to follow our agreed-to system of play and the resulting consequences."

Laura agrees. "We may not always agree on a bidding sequence, but we listen to each other's view." In almost 40 years of playing together, the Smiths have certainly had their fair share of high points. One was at the top of both of their lists: Achieving Life Master at a regional in Sacramento in 1990, and being presented commemorative etched glass cup by Jackie Mathews, one of their favorite tournament directors at the time.

And that's something they've helped other couples achieve as well. "We have had great pleasure in helping a couple of other married couples make Life Master by playing in Swiss games with them," Larry said. The Smiths are both Gold Life Masters now.

So what advice would these two veterans give to another bridge-playing couple who is just learning to play with their spouse? Laura says: Agree to disagree.

"This isn't any different than many bridge partnerships that are not spouses," Larry said.



Ross & Jeanne Hibler
Bridge: fun sharing time together

By Jen Smith

Ross and Jeanne Hibler of Salem, Ore., have been playing together for nearly 60 years. And shockingly enough, they've had no real fights in all that time. Maybe there have been a few heated discussions, Ross said, which fall into one of two categories: "Personal quirks which distract or annoy, and non-conformance to standard bidding and play, making partner uneasy."

So how do they resolve such disagreements? "Through continued discussion for as long as it takes, wherever we are," Jeanne says.

And while Ross says they'd be married with or without bridge, playing as partners has given them

the opportunity to share the game they enjoy together. Their transition to duplicate came late, and neither is a Life Master.

Ross has advice for those new to bridge. "Don't be overcritical of your performance. For the most part, you are playing against folks who had to learn just like you, and undoubtedly had initial experiences similar to yours," he said.

Jeanne added, "Expend your venom and competitive nature at the table in an acceptable manner and return home with the knowledge that your partnership is stronger for the experience."

A final word from Ross: "Accept and act on the belief that learning is never complete. The competition is with an opposing partnership, not with one another."

Hawaii North American Bridge Championships Aloha

Nov. 22 - Dec. 2, 2018 at the Hilton Hawaiian Village Waikiki Beach Resort

NABC Events	Friday Nov. 23	Saturday Nov. 24	Sunday Nov. 25	Monday Nov. 26	Tuesday Nov. 27	Wed. Nov. 28	Thursday Nov. 29	Friday Nov. 30	Saturday Dec. 1	Sunday Dec. 2
Nail LM Pairs	♠	♠								
Baze Senior KO (1 & 7:30 first two days, then noon & 7)	♠	♠	♠	♠	♠	♠				
0-10,000 Swiss Teams		♠	♠							
Mitchell Open BAM			♠	♠						
Marsha May Sternberg Women's BAM			♠	♠						
Super Senior Pairs (10:30a & 3:30p)			♠	♠						
0-10,000 IMP Pairs				♠	♠					
Kaplan Blue Ribbon Pairs					♠	♠	♠			
0-6000 Mini Blue Ribbon Pairs					♠	♠	♠			
Whitehead Women's Pairs					♠	♠				
Senior Mixed Pairs							♠	♠		
0-10,000 Fast Pairs (1 & 4:30)							♠	♠		
Reisinger BAM (1 & 7:30 Fri, noon & 7 Sat, 11 & 5 Sun)								♠	♠	♠
Keohane North American Swiss Teams (1 & 7:30 Fri-Sat, 11 & 5 Sun)								♠	♠	♠
NABC+ Mixed Swiss Teams (1 & 7:30 Sat, 11 & 5 Sun)									♠	♠

Regional Events	Friday Nov. 23	Saturday Nov. 24	Sunday Nov. 25	Monday Nov. 26	Tuesday Nov. 27	Wednesday Nov. 28	Thursday Nov. 29	Friday Nov. 30	Saturday Dec. 1
Regular Events	1 & 7:30	1 & 7:30	1 & 7:30	1 & 7:30	1 & 7:30	1 & 7:30	1 & 7:30	1 & 7:30	1 & 7:30
Open Pairs (unl./3000/750)	♣		♣			♣			♣
Open Pairs (unl./3000/1500) & Gold Rush Pairs		♣			♣		♣	♣	
A/X/Y (unl./6000/4000) & B/C/D (3000/1500/750) Pairs				♣					
Knockouts (four sessions)	♣	♣ ♣	♣	♣	♣ ♣	♣ ♣	♣	♣	♣ ♣
Compact Knockouts		♣		♣			♣		♣
A/X/Y Swiss Teams & Bracketed Flight B Swiss Teams			♣						
Open Swiss Teams & Gold Rush Swiss Teams						♣			
Afternoon Side Pairs (1p) (single sessions)	♣	♣	♣	♣	♣	♣	♣	♣	♣
Daylight Events	10a & 3p	10a & 3p	10a & 3p	10a & 3p	10a & 3p	10a & 3p	10a & 3p	10a & 3p	10a & 3p
Daylight Open Pairs (unl./3000/750)	♣		♣						
Daylight Open Pairs (unl./3000/1500) & Gold Rush Pairs		♣		♣	♣		♣	♣	♣
Fast Open Pairs (10a & 1p)						♣			
Daylight Knockouts (four sessions)				♣			♣		
Daylight A/X/Y & Bracketed Flight B Swiss Teams						♣			
Daylight Open & Gold Rush Swiss Teams			♣						
Afternoon Side Swiss Teams (3p)				♣	♣		♣	♣	♣
Morning Events	9a	9a	9a	9a	9a	9a	9a	9a	9a
Morning Knockouts (three sessions)	♣	♣		♣	♣	♣ ♣	♣	♣	
Morning Compact Knockouts (two sessions)	♣	♣	♣	♣	♣	♣	♣	♣	♣
Morning Side Pairs (single sessions)	♣	♣	♣	♣	♣	♣	♣	♣	♣
Morning Side Swiss Teams (single session)									♣
Evening Events	7:30p	7:30p	7:30p	7:30p	7:30p	7:30p	7:30p	7:30p	7:30p
Evening Side Pairs	♣	♣	♣	♣	♣	♣	♣	♣	♣
Evening Side Swiss Teams	♣	♣		♣	♣		♣	♣	♣
Evening BAM			♣			♣			
Late Events	11:30p	11:30p	11:30p	11:30p	11:30p	11:30p	11:30p	11:30p	11:30p
Midnight Zip KO		♣	♣	♣	♣	♣	♣	♣	

299er Events	10, 3, 7:30	10, 3, 7:30	10, 3, 7:30	10, 3, 7:30	10, 3, 7:30	10, 3, 7:30	10, 3, 7:30	10, 3, 7:30	10, 3, 7:30
299er & 49er Pairs	♥ ♥ ♥	♥ ♥ ♥	♥ ♥ ♥	♥ ♥ ♥	♥ ♥ ♥	♥ ♥ ♥	♥ ♥ ♥	♥ ♥ ♥	♥ ♥ ♥
299er Swiss Teams			♥ ♥ ♥						

Thursday, Nov. 22	1 7:30	Sunday, Dec. 2	10 2	Key
International Fund Open Pairs (unl./3000/750)	♣	A/X/Y Swiss Teams (unl./6000/4000)	♣ ♣	♣ Regional event - new beginning
International Fund 299er Pairs	♥	Bracketed Flight B Swiss Teams (0-3000)	♣ ♣	♣ Continuing event
International Fund Swiss Teams (unl./3000/750)	♣	Fast Open Pairs (10a & 1p)	♣ ♣	♥ 299er event (all single session)
Educational Foundation KO Teams (continues 9a Fri & Sat)	♣	Side Pairs (single sessions)	♣ ♣	♠ NABC event - first day
Educational Foundation Open Pairs (unl./3000/750)	♣	299er Pairs	♥ ♥	♠ Continuing event
Educational Foundation 299er Pairs	♥	299er Swiss Teams	♥ ♥	

Hilton Hawaiian Village Waikiki Beach Resort
 2005 Kalia Road
 Honolulu, Hawaii 96815
 808-949-4321

Room Rates start at:
 Resort view: \$195/night
 Partial Ocean View: \$225/night
 Ocean view: \$245/night
 Deluxe Ocean View: \$265/night
 Ali'i Ocean View: \$305/night

Call OnPeak at 855-992-3353 or email acbl@onpeak.com to reserve a room. You can also book online at acbl.org. Go to *Tournaments > Upcoming NABCs > Honolulu.*

AROUND THE UNITS

MaryAnn Beelart, Janie Penner, Evelyn Wick and Helga Petkovich won a special team game in Corvallis where players were required to team up with others their age.



Players over 90 win event for ages: Corvallis 'Decade Swiss'

It was the game of the decade in more ways than one. On May 12, the regularly scheduled Corvallis Membership Team Game was renamed the Decade Team Game. Players were asked to form teams of four people born in the same decade, regardless of their masterpoint status.

The idea was the brainchild of **Mary Alice Seville** who had a "wouldn't it be fun" moment while playing against two nonagenarians, **Evelyn Wick** and **MaryAnn Beelart**. She mentally paired those two with two other members in their 90s, **Janie Penner** and **Helga Petkovich**.

After Mary Alice brought up the idea to the board of directors and received whole-hearted approval, board member **Walter Dobek** took the ball and ran with it. He rounded up his own team of 70-somethings, then encouraged others to do the same. His efforts were rewarded. A record-setting 13 teams packed the bridge center that Saturday.

Mary Alice got her wish and the four nonagenarians formed a team. But by then, the team was comprised of three nonagenarians and one centenarian —

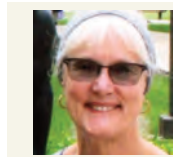

Albany/Corvallis
♣♦♥♠
By Kathi Downing
www.acbridge.org

Evelyn Wick had turned 100.

It was a great day to play bridge and all 52 of us fit more or less comfortably in the bridge center. Because our club loves to party, we put on a full spread, potluck-style, before the big game. After stuffing ourselves, we played our hearts (and diamonds and spades and clubs) out all afternoon.

By the time the dust had settled and scores tallied up, it appeared that our resident nonagenarians had won every round and outscored the rest of the field, against teams with many more total masterpoints than they had. An enthusiastic cheer went up as they were each presented with a framed certificate for their victory.

As **Dick Jarvinen** so aptly put it, these women "showed us young whippersnappers a thing or two."

Longtime Salem contributor Phyllis Hann dies

Have you ever taken the time to get a bridge player's story? Not necessarily their life story, but just a simple vignette from their past. Maybe it's how they learned to play bridge (I like those types of stories. Let me know if you have an interesting one) or maybe something interesting about their past life.

As you're sitting across from your partner at the club, or perhaps one of your opponents, if you have a little time at the end of the round, it might be worth swapping stories. You never know what fascinating things you might discover.

Comings and goings

Another issue, another obituary. This one is a tough one as we say goodbye to one of our longest-tenured players. **Phyllis Hann**, 98, died June 8. At the time of her death, Phyllis had almost 2100 masterpoints and had been playing bridge with us in Salem since at least the 1960s. I asked **Art Duraski**, who had played bridge with Phyllis for decades, to share with us some of Phyllis's contributions to bridge in Salem.

Duraski noted that Phyllis was a major contributor on the Salem tournament scene, including Salem's first and only regional tournament, along with the initiation of a second sectional event. On the administrative side, she was involved in establishing a governance board including the Salem, McMinnville and Woodburn clubs. Phyllis also contracted with a local Realtor to provide a home for Salem Bridge Club for over 10 years, then was part of the group that found a new home for the club after that property was sold.

On a happier note, the unit would like

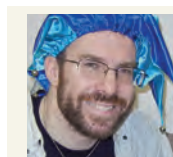

Salem
♣♦♥♠
By Kevin Kacmarynski
www.salembidgeclub.org

to welcome new member **Karen Chambers** of Keizer and also **Diane Hershberger** from the Phoenix area.

Tournament tales

The main event for Unit 490 over the summer was our own Salem Sectional held in Keizer in late June. Thanks to a nice turnout from our neighbors to the north in the greater Portland area, our southern guests from Albany/Corvallis, and a few visitors from further afield, the total attendance was up a half table from last year according to Unit President **Shain Oleson**.

Oleson also noted that the unit received many positive comments about the tournament, especially regarding the hospitality. Thanks to the tournament committee for putting on a great show.

Even with the presence of all our visitors, Unit members managed to snag several strat and overall wins during tournament weekend. First place overall winners included **Tom McGuire** and **Kevin Kacmarynski**, **Bill Gille** and **Laurie Nae-mura** (tie) with **Jan Petroski** and **Doris Sobala**, and the foursome of **Miriam Brand**, **Anita Walker**, **Dick Pitzer** and **Ellie Hall-Pitzer** in the Sunday BCD Swiss.

Congratulations to them and all our strat winners, which you can find online on the ACBL website.

Rick Soohoo of Vancouver won the weekend with 18.50 masterpoints. **Kevin**

Lessons coming; Labor Day party

Laurie Rowe will offer lessons for new players. The classes will be held at Emerald Bridge Club on Wednesdays from 6 to 8 p.m. for a fee of \$100 for the series of eight lessons. It is extremely rare for a teacher/player of Laurie's accomplishment to offer beginners' classes, and there can be no finer introduction to the game.

This year, EBC will host the annual Civil War match against our friends from the North on Saturday, Sept. 29. It will be a Swiss team event with three strats. Starting time is 10 a.m. with a break for lunch. Two years ago we had a sweep in all three strats and look forward to back-to-back wins. Go Ducks.

Sherri Morgan and **Don Marsh** planned to host their first Labor Day Garden Party at their Washington Street home last week. The festivities were schedule to get under way at 2 and continue until the police arrive. They plan to make it an annual event.

EBC has a new director. Congratulations to **Jeanne Savage** who took the test and is now officially certified. Look for her to pick up one of the games soon. Also,

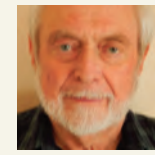

Eugene/Springfield
♣♦♥♠
By John Lean
www.emeraldbridgeclub.org

David Partridge is now directing the Wednesday evening game.

EBC continues to offer a 199er game, which has moved from Friday morning to Wednesday morning. A one-hour lesson/discussion follows each game.

Mary Egger hosted a picnic at her place for the 30th year. Wow, has it really been that long? It's a special event and just seems to get better with each passing year. Thanks also to **Terry Nagel** and all those who helped.

Some sad news: **Fred Coburn** died recently. He was the textbook example of a true gentleman. Also, **Norma Smith's** husband, Dennis, passed away. We offer our condolences.

For updates and more information about events, check our website: emeraldbridgeclub.net.

Central Oregon Coast
♣♦♥♠
www.unit572.org

The Central Oregon Coast unit still has not fallen into the ocean, as far as we know. Players from around the district are encouraged to go see for themselves when the unit hosts its sectional at the Shilo Inn in Newport, Oct. 25-28.

Participating in The Longest Day for the first time, the Bandon Bridge Club raised \$574 and the Bay Area Bridge Club in North Bend raised \$500.



Seaside/Astoria/Ilwaco
♣♦♥♠
By Capt. James Bernard
bridgewebs.com/seasideunit491

Did you get to the two grands?

'Tis the bold that get the gold! Did this really happen? At a recent Monday bridge game at our Ilwaco, Wash., club where we deal the cards, there were two back-to-back grand slams. Not every pair got there. But what fun!

Helpful player

We have one of our players who deserves recognition for his helpfulness in promoting our unit. He makes himself available to play with any and all beginners and others who do not have a partner. Frequently he picks up two of our 90-year-old ladies and brings them to the game. Hats off to **Manny Suarez**.

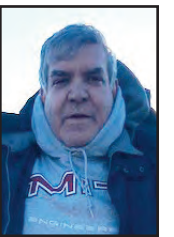

Manny Suarez

We all agree that the queen of promoting bridge in our area is **Sue Kroning**. But her husband, **Robert**, an expert bridge player, keeps us laughing with his jokes. One he offered us was: Why did the golfer wear two pairs of socks? In case he had a hole in one.

It was great to see **Connie Spencer** up from California for a three-day visit. Also, **Carol Van Dusen** was up for the summer.

New IMP pairs game

Once a month we will be running an IMP pairs game instead of a matchpoint pairs game. Winning tactics are like team competition: bid your games (especially vulnerable), play for plus scores, and be a coward, not a hero.

Race leaders

Masterpoint race leaders, as of mid-year: 0-20, Judhi Chopping, Ruth Johnson; 20-50, Thomas Stanley; 50-100, Sally Ann Wells; 100-200, Dan Moore; 200-300, Larry Marshall; 300-500, Maryjane Swynenburg; 500-1000, Margaret Brom; 1000-1500, Teresa Jefferson; 1500-2500, Lewis Richardson; 2500-3500, Douglas West; 3500-5000, Jon Gustafson.

Unit game results

Tom McGuire is the current leader in the race for the Lewis Award with 13.11 points won in unit games through July. Shain Oleson is nipping at his heels, only 0.18 points behind.

May 6 — 1A: Jackie Mishler — Claudine Lake, 2A: Shain Oleson — Jan Suggs, 3A: Lawrence Trickey — Garry Lowe.

May 16 — 1A: Irva Neyhart — Brian Breckenridge, 2A/1B: Jerry Gordon — Randy Jordan, 3A: Jim Gross — Dick Pitzer.

June 3 — 1A/1B: Tom McGuire — Norma Stofiel, 2A: Brian Breckenridge — Irva Neyhart, 3A: Zina Galaka — Dick Pitzer.

June 20 — 1A: Brian Breckenridge — Irva Neyhart, 2A/1B: Shirley Scofield — Art Duraski, 3A/2B/1C: Jerry Gordon — Wing Yung.

July 18 — 1A/1B: Shain Oleson — Jerry Gordon, 2-3A: Jeanne & Ross Hibler, 2-3A: Brian Breckenridge — Irva Neyhart.

Promotions

The unit would like to congratulate the following individuals on their ACBL rank increases: Shirley Crenshaw, Joanne Benkstein, Junior Masters; Stephen Jackson, Susan Jackson, Club Masters; Terry Hart, Jeanne Hibler, Ross Hibler, Kathleen McCrossin, John Chi, Karen Crooch, Doug Reed, Shirley Layne, Sectional Masters; Barbara Nelson, Susan Braden, Regional Masters; and Ann Teal, NABC Master.

Don Pitt is a new Life Master. Milestones include Paul Graham, Bronze Life Master, and Jim Gross, Sapphire Life Master.

AROUND THE UNITS



Ontario



By Inge Dickerson

Ontario raises \$2000 for PEO

Several couples from the Ontario Bridge Club attended the Longest Day play in Boise. But, alas, we came home with nothing to crow about. There's always next time.

In June, **Anne Oglevie**, who is our bridge education coordinator for novices, organized a luncheon and charity game in Weiser, Idaho. She got nine tables into play, to benefit the Philanthropic Education Organization for Women. Her group is proud to have raised \$2,000.

On July 9, we had eight and a half tables in play for the special Instant Matchpoint Game. **Lorinda Pearson** with **Mary Jo Rode** and **Doris** and **Hugh Homan** each won the coveted gold point.



Doris Homan, Jana Schaffeld, Hugh Homan

Doris and **Hugh Homan** are a very recent additions to our club, and they are also the parents of **Jana Schaffeld**, who has been with us for several years. Doris and Hugh are accomplished duplicate players, but because they are new ACBL members, they are playing in Flight C and winning a lot. We welcome all to our club.

A couple of our members are dealing with health issues. We wish **Sue Carlton**, who is our intrepid vegetable snack provider, and **Sally Baker**, who is tutoring novices, speedy recoveries.



Boise raises \$5800 for TLD

Superhero bridge players from Boise, Nampa, Caldwell and Ontario came out in force June 23 to play in The Longest Day event and raise money for the Alzheimer's Association.

Unit 394 hosted the highest grossing event on the Longest Day for the Alzheimer's Association of greater Idaho. We all recognize the tragedy of Alzheimer's and know someone affected by the disease. ACBL's partnership with the Alzheimer's Association is an apt one as the game keeps our brains sharp and, we hope, dementia at bay.

Janet Mathews' complimentary breakfast with homemade breads and muffins drew enough players to fill 15 tables for the morning session, twice as many as last year. Players were encouraged to come and play even if they didn't have a partner. **Karen Boss**, the unit's matchmaker, paired players all day long.

Linda Anderson and her crew provided chicken salad for lunch. During the break, **Craig Jones** gave a short lesson on the Rule of 11. Nineteen tables, almost all in purple, settled down for a chair yoga lesson by Jill Boyer of Boise's Senior Center. She emphasized the importance of continued stretching and exercises, to maintain mental acuity and flexibility. Awards were given to those who traveled the farthest and there were several door prizes.

Our silent auction, which had been at



Boise



By Ian Martindale

boisebridge.club

the club for a week, also raised money for the charity. During dinner, **Craig Jones** offered a second lesson on reverses. The crowds thinned a little but we still ended the evening with a nine-table game.

Who knew that 43 tables, a silent auction, raffle tickets, t-shirt sales, lunch and dinner tickets, and donations would add up to almost \$6,000? We had set a goal of \$4,000 this year, but when our treasurer, **Gene Gerard**, added it all up we beat that and increased last year's total by 54%. Turns out we had seriously underbid our hand for the Longest Day. The Treasure Valley and our friends in Ontario are a generous group of bridge players. We thank everyone who showed up to play and donated. We thank the Bridge Cooperative of Boise for use of the club and their raffle donations. Thanks to **Ian Martindale** and **Kathy Downen** for directing the games for free.

The Longest Day Committee was Nancy Feldman, Cheryl Maderazo, Kathy Luft, Linda Anderson, Gene Gerard, Janet Matthews, Karen Boss, Ian Martindale and Phil Emerson.

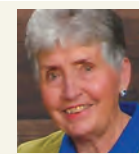

Nampa/Caldwell



By Marilyn Tripple

Certificates are on the way

I am so excited to see a message posted on July 26 by our club manager: "July 30 Swiss team – Quarterly Club Championship, with preduplicated broads." Sign me up for that deal as one of the "broads."

Just checked around here in my home office in Nampa, and wouldn't you know, found a soapbox to stand on: On July 9, we had a game that was advertised as giving a gold point, one each to N/S and E/W winners. And, who do you suppose won those two gold points? Individuals who already have lots of them. **Linda Brinton** and **Larry Chase** were awarded the one point N/S, and **Duane Christensen** and **Ian Martindale** were awarded the one point E/W.

I have just sent an email application to Member Services at ACBL, requesting some of us be issued the title Golden Age Master. In a recent Bridge Bulletin it was noted that any ACBL member who has 300 or more masterpoints and is at least 70 years old, or who has 100 or more masterpoints and is at least 80 years old, can be issued a certificate designating them as a Golden Age Master. Sign us up!

In a recent board meeting, president **Anita Hansen** announced our annual sectional is scheduled for Nov. 2-4. It will be held at the same location we used so successfully last year, the Hispanic Cultural Center in Nampa. We look forward to seeing all the usual attendees from near and far. It's a great venue with good food and enjoyable bridge.

Chico leads D20 in new members



Chico



By Rick Shipley

According to recent data from the ACBL, new player gains of the last 12 months show Unit 457 is the No. 1 ranked unit in District 20 (out of 23), and the sixth-ranked unit in the ACBL (out of 295). We heartily thank all those who have spearheaded the effort to teach and mentor the new players.

The format for much of this success was initiated when a few Chico leading players asked the local university if they could teach a bridge class. Given one hour each Friday for six weeks, the class was attended by a surprising 20 people. After the course, the new players were bolstered with real club experience, close mentoring, and masterpoints. Many of the students are now regulars at the club. We hope other clubs can benefit by the sharing of ideas that have potential.

On June 24 our Mohammed Shagrun Memorial (aka Summer Bash) was attended by 23 pairs. In



The Yuba City Club moved into a new location at St. John's Episcopal Church in Marysville, where stained glass windows adorn the room they play in.

first place were **Charles Hodel** and **Steve Kaessner**. See additional results below.

YC club moves to new location

The Yuba City Club has moved to a beautiful new location across the Feather River. They now play at the St. John's Episcopal Church, located at Eighth and D streets in Marysville, where they will also hold the Sutter Buttes Sectional each August.

Big games: The Bidwell Club in



Chico has once again reported six sessions of over 70% since mid-April. We offer congrats to **Carol Huston** (over 70% twice), **Steve Kaessner**, **Garth Gregory**, **Doug Jacobs** (three times), plus **Gloria Shagrun** paired with **Mark Bloom** to garner a hot 76.9% in July.

Results

Mohammed Shagrun Memorial, June 24 — 1: Charles Hodel — Steve Kaessner; 2: Carolyn Bergholdt — Mary Mayfield; 3: Carol Huston — Mark Bloom; 4: Gloria Shagrun — Jo Anne Murdock; 5: Garth Gregory — Judy Pede.



Redding



By Joan Sullens

www.bridgescore.com/redding

Redding raises \$1600 for TLD; Instant Matchpoint winners

We lost two of our Redding players recently, **Polly Dense** and **Kathy Callahan**. They were longtime members, leaving behind many friends. Our sincere condolences go out to their families.

The Longest Day Games in June netted over \$1,600 for the Alzheimer's charity.

Instant Matchpoint Games played at Redding Club had the following players earning gold points: **Florence Hungerford** and **Judy Hotchkin**, **Jim** and **Carol Reed**, **Marlene Lamoreaux** and **Wilhelmina White**, and **Gene Biek** and **Joan Sullens**.

There was just one 70% game last term. That was accomplished by Johnny Brazo and Margaret Hughes.

Our fall sectional is coming up the first weekend in November. Time to line up your partners. Hope to see not only our regulars but many restricted side players come join the fun.

Results

The Longest Day, Redding Club — 1A: Wilhelmina White — Marvin Grudem, 2A: Florence Hungerford — Judy Hotchkin, 3A/1B: Jim & Faye Hickenbottom, 2B: Carole Schmitz — Ken Murray, 3B: Jim & Carol Reed, 1C: Joann Jensen — Terry Ehlers, 2C: Jeff & Kim Speer.

Restricted: 1D: Margaret Hughes — Johnny Brazo, 2D: Jackie McCall — Elsa Zoll, 3D: Kelly Gutierrez — Don Jacobs.

The Longest Day, Bridge Werks Club — 1A/1B: Jerry Clark — Mickey Thomas, 2A: Marvin Grudem — Wilhelmina White, 3A/2B: George Clarke — Michael Hollins, 3B: Jim & Carol Reed, 1C: Nikki Blum — Don Jacobs, 2C: Jackie McCall — Pen Boehme.

AROUND THE UNITS

Future Stars Sectional to host 99ers

As part of an ongoing effort to help newer players improve their game and groom them for open competition, a Future Stars Sectional just for 99ers will be held Nov. 10–11 at the Phoenix Bridge Center near Medford.

It is sponsored by Unit 484 (Jackson County) and Unit 481 (Grants Pass, Brookings and Roseburg).

The two-day sectional is different from other sectionals in that only one session will be played per day.

On Saturday, Nov. 10, there will be a single-session Swiss teams event at 11 a.m. On Sunday, a single-session pairs game is set for 11 a.m.

Co-chairs of the event are **Gee Gee Walker** and **Nancy Hitchcock**.

“Players can contact either one of us for information or if they’re looking for partners or Swiss teammates,” said Walker.

Walker can be reached at 541-292-3474 or at ggwalker@gmail.com. Reach Hitchcock at 541-479-9436 or at jnhitchcock@charter.net.

“In addition to the teams event on Saturday, there will be a short workshop on Swiss team strategy at 10:30 a.m.,” said Hitchcock. A complimentary lunch will be served during a mid-session break.

“On Sunday, there will be complimentary coffee and snacks,” Walker added.

The Phoenix Bridge Center is located at 4149 Pacific Highway South (Highway 99). Take I-5 exit



Jackson County
♣♦♥♠
By Jim Flint
www.unit484.org

24 to Phoenix, turn right at the light on Highway 99, and go one block. The center is on the right.

Player fees are \$8 per session, \$12 for lapsed members. Temporary memberships will be available at the venue.

Spring sectional

At its June board meeting, unit 484 named president **Don Walker** as chairman of the Spring’s-a-Poppin’ Sectional, set for March 29–31 next year.

“In addition to 299er pairs and open pairs events, we’ll also have a special 99ers session on Saturday morning,” Walker said.

Those 99er and 299er games are subject to player availability, and are single-session events. The open pairs events are played as two single sessions on Friday and play-through sessions on Saturday. Swiss teams, stratified by average masterpoints, will be played on Sunday.

All sessions are at 10 a.m. and 2:30 p.m., although the afternoon session of the Swiss teams may be earlier with a lunch available on site.

Player fees per session are \$10 for members, \$14 for lapsed members, and \$9 for members with less than 50 masterpoints.

Steve Kaessner will direct. Partnerships chair is Gee Gee Walker, 541-292-3474 or ggwalker@gmail.com.

Making waves

Some of the intermediate players who have started playing in the open games are making the more experienced players sit up and take notice.

Frequently placing in the open games are **Jill Wolcott, Bob Wolcott, Kay Bain, Kathleen Moore, Karen Schoessow, Jean Zebedee, Jody Larson, Marsha Larson, Helen Mills, Pam Howard, and Marion Gribben**. Jody Larson, Bain, Moore and the Wolcotts all came in first against the open players in recent games.

Holiday unit party

What has become a tradition on the first Saturday of December, the quarterly unit game will celebrate the holidays with open pairs, 199er pairs, and a free dinner, courtesy of the unit.

Scheduled for noon on Dec. 1, the dinner will be served at 11:30. A short business meeting will precede the game. Don Walker, president of the board, is the coordinator.

Very big game

Terry Ansnes and **Mark McKechnie** hit the heights in a three-table session at the Tuesday night club on June 19 with a 76% game. They took all of the matchpoints on about half the boards.



Klamath Falls
♣♦♥♠
By Bobby Thompson
www.unit482.com

Player’s grandson a promising golfer

Fall is my favorite time for walking. The weather is picture perfect with the leaves turning yellow, orange and red colors, so life is good.

The Oregon State Beaver baseball team did themselves, alumni and the state of Oregon proud in winning the 2018 NCAA Division I national championship in Omaha, Neb. It was the school’s third title, winning also in 2006 and 2007.

Let’s turn to the Oregon Ducks golf team for a moment. They wooed the best high school golfer in the state, **Craig Ronne** of Klamath Union, to Eugene. His grandmother, **Nancy Nealy**, is one of our duplicate players. Ronne, at 5 foot 7, drives the ball 325–350 yards and Duckville has been after him since his freshman year in high school. Look for him to be on the pro tour down the line, as he is that good.



Craig Ronne

We want to welcome a new member to our Klamath Falls group. **Gail Pfrimmer** moved to K.F. from Nashville, where her late husband was a songwriter. At her first time at the club, she was a winner with **Petra Gellner**.

More bridge in the basin featured five big games of which three were of the “big boy” variety by **Doug Higgs** and **Bobby Thompson** (78.7), **Randall Paul** and **Keith Thorp** (77.1), **Ed & Carol McClure** (74). This is not to slight the efforts of Higgs and Thompson (71.53) and **Laila Griffith** and Thompson (71.4).

Second quarter point parade leaders were: Thompson, Higgs and Griffith while the top three NLM players included: **Reid Sherwin, Patti Collom** and **Ethel Rust**.

Evelyn Duncan passed away June 28. She and husband Kenneth lived in Malin and would drive 60 miles twice a week to play bridge. After 40-plus years they retired in 2010 from the journey back and forth to Klamath Falls and played cards at home with family and friends.

If you’re at the Rogue Valley Sectional (Sept. 14–16) you’re getting information about fourth quarter tournaments with the **Oregon Coast Regional** in Seaside (Oct. 1–7) and the Central Coast Sectional (Oct. 25–28) in Newport. Fall is always beautiful on the coast.

Give yourself an early Christmas present by heading to Hawaii for the Fall NABC in Honolulu (Nov. 22 through Dec. 2) at the Hilton Hawaiian Village. It’s a great place to kick back and enjoy your time with family and friends. Over 40 years ago about 20 members of Unit 482 attended the national in Hawaii at the same location and we had a fantastic time. Aloha!

Results

Club Championship, April 21 — 1A: Bobby Thompson — Doug Higgs, 2A: Laila Griffith — Carol McClure, 3A/1B: Kathy Kerr — Jo Ann Siebecke, 2B: Patti Collom — Judy Shelton.

Unit Game, May 6 — 1A: Randall Paul — Bobby Thompson, 2A: Ed McClure — Doug Higgs, 3A: Rodney Paxton — Henriette Mufich.

Club Championship, May 24 — 1A: Bobby Thompson — Keith Thorp, 2A/1B: Reid Sherwin — Patti Collom, 3A: Laila Griffith — Carol McClure, 2B: Tom and Petra Gellner.

Unit Game, June 10 — 1A: Ed McClure — Doug Higgs, 2A: Randall Paul — Bobby Thompson, 3–4A: Laila Griffith — Carol McClure, 3–4A/1B Dale Taylor — Keith Thorp, 2B: Tom and Petra Gellner.

Unit Game, July 8 — 1A: Ed & Carol McClure, 2A/1B: Reid Sherwin — Duane Weiss, 3A/2B: Dale Taylor — Keith Thorp.



Brookings Tri-City Bridge Club
♣♦♥♠
By Debbie Grasham

Brookings adds newcomer games

Bridge things are happening in Brookings. We now have two newcomer games each month, the second and fourth Tuesdays. We offer extra newcomer play before our regular games on Mondays and Thursdays, where newcomers can get help with their bidding and their play from more experienced players.

We also participated in the Instant Matchpoint Game on July 9. The winners at our club, **Steve Carter** and **Steve Prokop**, had an impressive 69.3% game and won a gold point.

We are planning another section of Learn Bridge In A Day classes in the fall. The previous three sessions have been popular and we have attracted new and returning players to come to our small club.

Big games include a 70% score by **Ned Flaxington** and **Kirk Roberts** in March.

Nevada County
♣♦♥♠

Nevada County Unit 461 raised \$3225 for the Alzheimer’s Association with its The Longest Day event. The unit had the second-highest total in District 20.

The unit’s sectional is Oct. 10–12 at the St. Canice Center in Nevada City. Explorers are welcome to verify that this part of the district is still there.

Grants Pass
♣♦♥♠

Unit donates Sunriver profits; Redmond game has evolved

Pat Douglas has been running a Thursday afternoon game at the Redmond Senior Center since 2011, but it’s a little different kind of game these days.

Originally it was designed as a stepping stone for players with less masterpoints as they honed their game with players with similar skill. It has now evolved to a game where players across a broad spectrum of bridge accomplishments are welcome. Thank you, Pat, for providing “your little heaven” as an enjoyable place to play.

The unit hosted the 2018 regional in Sunriver in May. Although attendance was down from two years ago, those who did attend enjoyed a most rewarding experience. Many thanks to unit members who volunteered, including **Chip** and **Berta Cleveland, Dee Cockfield, Larry** and



Pat Douglas



Bend/Redmond
♣♦♥♠
By Ken Waskom
www.bendbridge.org

Laura Smith, Susan Battistella and **Carolyn Henning**.

The weather during the entire event was central Oregon perfect. The unit donated the surplus from the event to the Mountain Star Relief Nursery, a wonderful local organization which helps young parents and their children develop family skills.

Congratulations to **Ron Foerster**, our newest Life Master. After playing against Ron for the last few years, it is hard for me to believe that he was not had the title for a long time.

Planning is underway for our 2019 sectional. Stay tuned for dates and location to be announced.

Sadness strikes Eureka players

It’s a brief report this issue, but out Eureka friends will understand. As your unit reporter, I enjoy covering the news of our players, but the loss of my husband, **Ken**, my partner in more than bridge for 52 years, slowed me down considerably.

The club also lost **Bobby Lorenson**, an astute player in our club for more years than most of the rest of the players have played together. To add to the sadness, one of our members, **Sharon Hebert**, suddenly lost her son in a bicycle/vehicle accident.

Needless to say, we are saddened and subdued.

The Grants Pass unit is joining with the Jackson County unit to host the Future Stars Sectional, an event for players under 100 masterpoints, Nov. 10–11, in Phoenix. See the Jackson County unit report for more information.



Eureka
♣♦♥♠
By Frederica Aalto
www.acbdld20.org/unit458

However, one of the functions of a bridge club is to divert us from our troubles for a few hours at least. Looking forward, I hope that I see many of you at our sectional in the second weekend of September. Out of bridge for a bit, I hope to be back by then and will be looking for you.

AROUND THE UNITS



Vancouver/Longview
♣♥♦♠
By Ginny Griffiths
www.acbld20.org/vbc

Wilson's long road to Vancouver

In this issue's column, we'd like to honor our director, **Garland Wilson**, born in a log cabin (really) in Arkansas, moving with his family at 3 years old to Los Angeles.

After school, he enjoyed a career as an electrician.

Garland and his wife, Jude, have been married for 55 years and have two children. Randy is in advertising and Barbara works for Paul Allen as a liaison for the firm with the government.

The couple has four grandchildren.

Garland started playing bridge in the 1960s and played against Barry Crane at Palm Springs and against Easley Blackwood at Mab's Bridge Club in California.

Garland moved to Brookings, Ore., after he retired and became a Life Master in 1996. In 2000 he moved to Vancouver where he started directing.



Garland Wilson

Sectionals stay put; big special games at clubs

In late July, Unit 487 board members decided to continue holding sectionals at Montgomery Park, where scarce Friday parking has limited the playing days to Saturday and Sunday, and add STaC games for the preceding Thursday and Friday at the Ace of Clubs and Portland Bridge Club. The board reached this decision after review and discussion of surveys distributed earlier to the entire unit membership.

Board members began work toward sanctioning the STaC games and hoped to complete it in time for the September tournament. To help cover growing sectional costs, the board also agreed to raise the table fee to \$12 per person per session.

Active summer for area clubs

A number of special events over the summer attracted Ace of Clubs players, among them former local **Judy Kay**, who now lives in Florida most of the year. Those events commenced with The Longest Day activities in June, which raised more than \$1,400 for the Alzheimer's Association.

The club also hosted 16 tables on the Fourth of July and, a week later, 13 tables for Bastille Day. Also added to the calendar were Octoberfest games Oct. 12-14, a 299er potluck Oct. 17, a Halloween special Oct. 31, and the club's annual Christmas party on Saturday, Dec. 8.

At the Portland Bridge Club, The Longest Day event raised more than \$2,400 for Alzheimer's research, and on July 4 the club hosted a whopping 23 tables for its Independence Day and NABC



Portland
♣♥♦♠
By Martha Maroney
www.acbld20.org/unit487

promo potluck and game.

Striking platinum

Stu Swan of Portland recently surpassed 10,000 masterpoints, becoming the 10th Platinum Life Master in District 20.

"I told myself I wouldn't kill myself," Stu said, regarding reaching the milestone. "If I had played as much as everyone else, it would have happened a long time ago."

A word of advice? "Don't ask your partner to bid what you're looking at." Thanks, Stu! Congratulations!

Playing hooky

Your reporter, a native Texan, missed a few Portland-area games the first week of July, but wound up playing more than a few in the city I was visiting for family reasons — Austin, Texas, which just happened to be hosting the District 16 Austin Firecracker Regional.

Scrambling, I managed to arrange a partnership for two sessions with a Dallas-area player I knew from BBO, and with the help of Robin Tucker, partnership chair at the Bridge Center of Austin,



Stu Swan
Platinum Life Master



At the Austin Regional, held over the Fourth of July, players dressed in patriotic attire. Martha Maroney recently visited family in Texas during the regional. Below: Julius Grossenbacher sings the national anthem.



I found four other skilled, friendly players to get me through a total of nine sessions over the week.

Playing two days of Gold Rush Pairs and the rest side games, I returned to Oregon with a less-than-Texas-size haul of masterpoints, but the fun of attending a big tournament in my home state provided ample compensation.

Understanding the schedule and how to win Gold Points at The Oregon Coast Regional at Seaside

(All events pay red or gold points, but gold points can only be won in two-session events)

Are you a non-Life Master looking to win gold points?

Here are all the events in the Oregon Coast Regional, listed in the order of your best chance.

GOLD PAIRS (750/300/200)

All players must have under 750 masterpoints. There are three strats - you can win gold for first place in your direction in either session, or for finishing in the top quarter of the players.

This week: There are five of these two-session events, at 1 pm and 7 pm on Tuesday, Wednesday, Thursday, Friday and Saturday.

BRACKETED KNOCKOUT TEAMS

The directors place your team of four players in separate groups (brackets) of similar masterpoint average. You only play matches against other teams in your group. Although you pay for only one session at a time, be sure you are available for all the future sessions because each time you win you will come back for the next session. If you make it through the first two sessions, it is guaranteed you will win gold points. All matches are either head-to-head, so you play the same team all session, or a round robin where you play two other teams and actually have a better (2 out of 3) chance of going on to the next round.

This Week: There are five knockout team events, all four sessions long, one starting every day Monday through Friday. On Saturday there is a two-session compact KO in which you play two teams per session.

BRACKETED FLIGHT B SWISS TEAMS (Under 2000)

This bracketed event is limited to players with under 2000 masterpoints, and then the teams are bracketed into masterpoint groups and you only compete against others with similar masterpoint totals to yours. Good chance for gold points!

This week: One two-session event on Sunday at 10 am and TBA (to be announced).

SIDE GAME SERIES (STRATIFIED OPEN PAIRS)

The Side Game Series are always multi-session pairs events. There are two ways to win gold points:

1. A section top in Strat A (but to receive the gold points you must play in at least two sessions.)
2. At the completion of the event your two best individual percentage scores determine your overall position, and may win you extra gold.

This Week: This regional has three separate Side Game Series events, one in the mornings at 9 am, one in the afternoons at 1 pm and one in the evenings at 7 pm. Each event has 5 or 6 sessions and each session is a stratified pair game, with awards given for each individual session, and later for the overalls.

MID-FLIGHT PAIRS (2000/1250)

All players must have under 2000 mps. This new limited two strat event is occasionally offered as a step above the Gold Rush Pairs.

This Week: Wednesday and Thursday at 1 & 7.

EAST PAIRS (Open/2000/750)

Open and stratified. Instead of the usual seven to eight minutes allowed to play each board, boards must be completed in five minutes. Gold points for a section top in all strats plus overalls.

This Week: Traditionally held on Sundays at 10 am and 1 pm for those who want to leave early.

THREE STRAT OPEN PAIRS (Open/3000/1500)

These two-session events are only offered when a Gold Rush Pairs is scheduled. They are open and stratified.

This Week: Tuesday, Friday and Saturday at 1 & 7.

A/X/Y SWISS TEAMS (Open/4000/2500)

The A/X/Y event is open and stratified. It is played at the same time as the Bracketed Flight B Swiss Teams so most players will have over 2500 masterpoints.

This week: At 10 am and TBA (to be announced) on Sunday.

SINGLE SESSION EVENTS - RED POINTS ONLY

99er STRATIFIED PAIRS (100/50/20)

All players have under 100 masterpoints. Newer players may find these friendly events the most comfortable for them with the best chance to win.

This week: There are single-session 99er Pairs every afternoon Tuesday through Saturday at 1 pm. Red points only for single-session events.

299er STRATIFIED EVENTS (300/100/50)

All players have under 300 masterpoints. I/N (Intermediate/Newcomer) players may prefer these limited events competing only against their peers.

This week: Single-session 299er Pairs on Monday evening and every morning, afternoon and evening Tuesday through Saturday at 9 am, 1 pm and 7 pm. Red points only for all these events.

STRATIFIED SWISS TEAMS (Open/2500/750)

Sometimes called a "loser Swiss" this evening event mainly caters to teams which are eliminated in an afternoon bracketed KO.

This week: There are five single-session open stratified team events at 7 pm on Tuesday through Friday. There is also a Charity Swiss on Monday evening.

Note: For all stratified events, overall in the top stratum is determined by comparing all scores. Then, the scores from the A players are eliminated and a separate B ranking takes place for the remaining pairs or teams. Next, the scores from the B players are eliminated and a third ranking determines the C places.

District 20 Seeks

New Co-Tournament Manager

The D20 Co-Tournament Manager is responsible for running two D20 regionals a year. The position pays a stipend plus expenses, which will be determined by the D20 Board.

For a complete job description, please go to the D20 Manual of Policies and Procedures at:

http://web2.acbld20.org/board/MOPP/D20_MOPP_A_5_TnMan.pdf

Requirements include: Excellent people skills; excellent organization skills; familiarity with Word, Excel and Publisher; the ability to travel to two D20 mainland regional tournaments annually; and knowledge of bridge and bridge tournaments.

Responsibilities include: Having your phone number and email address listed for correspondence and communication; arranging meetings and tournaments; designing, printing and distributing tournament flyers; hiring and overseeing The Daily Bulletin editor and a photographer; supervising the tournaments; arranging for hospitality and payments to caddies and for gratuities; making hotel arrangements; and more.

To apply, please send a letter of interest and resume to:

Marie Ashton

6512 SW Midmar Pl.

Portland, OR 97223

Phone: 503-244-5733

Email: marieashton@comcast.net

For further details about the work entailed, please contact Marie Ashton at the address and phone number listed above.

Candidates must reside in D20.



Coming in 2019

68TH HAWAIIAN REGIONAL Jan. 7-13, 2019



DIRECTOR IN CHARGE

Matt Smith

PARTNERSHIPS

Lily Johannessen

lily.johannessen@gmail.com

808-341-6041

TOURNAMENT CHAIR

Glenn Mason

gm@masonarch.com

808-387-1256

HAWAII PRINCE HOTEL WAIKIKI

100 Holomoana Street
Honolulu, HI 96815

Phone: (808) 956-1111 Ext. 56

or (800) 321-6248

Fax: (808) 944-4491

reservations@princehawaii.com

Restaurants feature
Hawaii regional cuisine
and Japanese delicacies.

TOURNAMENT LINK: <http://tournaments.acbl.org/schedule.php?sanction=1901060>



Join us for entertaining presentations
by various speakers between sessions!



DRESS CODE

No bare feet allowed. Bermuda
shorts O.K., but no short shorts



CONTACTS & INFO

DIRECTOR IN CHARGE: Matt Koltnow
TOURNAMENT MANAGER: Jean Johansson

gorgonb@aol.com; 503-577-4484

PARTNERSHIPS: Chuck Burns

charlesleeburns@gmail.com; 360-694-9664

I/N COORDINATOR: Margi Redden

d20incoord@yahoo.com; 503-805-2103

◆ Speakers ◆ Mini-lessons ◆ Party ◆ Gold Rush Pairs ◆



Meriwether Lewis

February 18-24, 2019

THE OREGON TRAIL REGIONAL



William Clark

SCHEDULE

Monday, Feb. 18

7 p.m. Columbia River Bracketed KOs
(winners continue at 1 & 7 p.m. Tuesday)
7 p.m. Stratified Open Charity Pairs
(Evening Side Game Series 1 of 6)
7 p.m. ◆ 299er Stratified Charity Pairs

Tuesday, Feb. 19

9 a.m. Morning Side Game Series (1 of 5)
9 a.m. & 1:15 p.m. ◆ Honeysuckle Gold Rush Pairs
1 & 7 p.m. ABC Pairs
1 & 7 p.m. AXY Swiss Teams
1 & 7 p.m. ... Bracketed Round Robin Teams (under 2500)
1 p.m. Afternoon Side Game Series (1 of 5)
1 p.m. ◆ 299er Stratified Pairs
7 p.m. Stratified Swiss Teams
7 p.m. ◆ Tuesday/Wednesday Evening Gold Rush Pairs
(single session entries welcome)
7 p.m. Evening Side Game Series (2 of 6)

Wednesday, Feb. 20

9 a.m. Morning Side Game Series (2 of 5)
9 a.m. & 1:15 p.m. ◆ Rose Gold Rush Pairs
1 p.m. Vancouver Bracketed KOs
(winners continue at 7 p.m.; and at 1 & 7 p.m. Thursday)
1 & 7 p.m. ABC Pairs
1 p.m. Afternoon Side Game Series (2 of 5)
1 p.m. ◆ 299er Stratified Pairs
7 p.m. Open Single Session Swiss Teams
7 p.m. 0-2500 Single Session Swiss Teams
7 p.m. ◆ Tuesday/Wednesday Evening Gold Rush Pairs
(single session entries welcome)
7 p.m. Evening Side Game Series (3 of 6)

Thursday, Feb. 21

9 a.m. Morning Side Game Series (3 of 5)
9 a.m. & 1:15 p.m. ◆ Lilac Gold Rush Pairs
1 & 7 p.m. ABC Pairs
1 & 7 p.m. AXY Swiss Teams
1 & 7 p.m. Bracketed Round Robin Teams (under 2500)
1 p.m. Afternoon Side Game Series (3 of 5)
1 p.m. ◆ 299er Stratified Pairs

Thursday, Feb. 21 (continued)

7 p.m. Stratified Swiss Teams
7 p.m. ◆ Thursday/Friday Evening Gold Rush Pairs
(single session entries welcome)
7 p.m. Evening Side Game Series (4 of 6)

Friday, Feb. 22

9 a.m. Morning Side Game Series (4 of 5)
9 a.m. & 1:15 p.m. ◆ Azalea Gold Rush Pairs
1 p.m. Mount Hood Bracketed KOs
(winners continue at 7 p.m.; and at 1 & 7 p.m. Saturday)
1 & 7 p.m. ABC Pairs
1 p.m. Afternoon Side Game Series (4 of 5)
1 p.m. ◆ 299er Stratified Pairs
7 p.m. Open Single Session Swiss Teams
7 p.m. 0-2500 Single Session Swiss Teams
7 p.m. ◆ Thursday/Friday Evening Gold Rush Pairs
(single session entries welcome)
7 p.m. Evening Side Game Series (5 of 6)

Saturday, Feb. 23

9 a.m. Morning Side Game Series (5 of 5)
9 a.m. & 1:15 p.m. ◆ Tulip Gold Rush Pairs
1 p.m. Ridgefield Compact Bracketed KOs
(winners continue at 7)
1 & 7 p.m. AX Pairs
1 & 7 p.m. BC Midflight Pairs (under 3000)
1 p.m. Afternoon Side Game Series (5 of 5)
1 p.m. ◆ 299er Stratified Pairs
7 p.m. Open Single Session Swiss Teams
7 p.m. 0-2500 Single Session Swiss Teams
1 p.m. Evening Side Game Series (6 of 6)

Sunday, Feb. 24

10 a.m. & TBA AXY Swiss Teams
10 a.m. & TBA .. Bracketed Round Robin Teams (under 2500)
10 a.m. & 1 p.m. Stratified Open Fast Pairs
10 a.m. ◆ 299er Swiss Teams

Table Fees:

ACBL members \$13;
unpaid \$17; under age 26, \$6.

STRATIFICATIONS

ABC Pairs: Open/3000/1500
◆ Gold Rush Pairs (Under 750): 750/300/200
AX Pairs: Open/4000
BC Midflight Pairs (Under 3000): 3000/1500
◆ 299er Stratified Events (Under 300):
A: 100-300, B: 50-100, C: 0-50.
Stratified Swiss Teams: Open/2500/750
Open Single Session Swiss Teams: Open/5000/3000
0-2500 Single Session Swiss Teams: 2500/1250/500
AXY Swiss Teams: Open/5000/3000
Bracketed Round Robin Swiss Teams (Under 2500):
0-2500 (no player over 2500); groups by MP range; gold
points in each group.

Eligibility for flighted events based on top player's MP total.
Thereafter, strats determined by average of pair or team.

◆ Indicates I/N (Intermediate/New-comer) events.

LODGING VANCOUVER, WASHINGTON HILTON

801 W. 6th Street,
Vancouver, WA 98660.

(Across the bridge from Portland, OR)

RESERVATIONS: Direct link at
acbl20.org or online at
vancouverwashington@hilton.com
(code ACB); or phone 360-993-
4500 or 1-800-445-8667 and
ask for code ACB.

Rates: \$139 and up.
Cutoff Date: Jan. 31, 2019,
or when room block is full.

Parking: Park 'N Go at 6th &
Washington.

Directions from Portland:
North over I-5 bridge; exit 1B
City Center; left lane to E. 6th.
Directions from North: From
I-5 S exit 1C Mill Plain Blvd; left
on Washington, right on W. 6th.



ACBL DISTRICT 20
www.ACBLD20.org

Morning Side Game Series
 (102 players)
 1-2 Michael Dalton, Palm Coast FL
 1-2 Estelle Kevitch, Salt Lake City UT
 3-4 James Smith, Mapleton OR
 3-4 Jon Neimand, Eugene OR

WINNERS AT THE GREAT POTATO REGIONAL

Afternoon Side Game Series
 (141 players)
 1-2 Doug Adair, Midvale UT
 1-2 Julianne Adair, Midvale UT
 3-4 Barbara Seagram, Toronto ON
 3-4 Alex Kornel, Toronto ON

Barbara Seagram seminar



Barbara Seagram's well-attended seminar provided a crucial boost to the regional, which held nearly level with 2016.

Tournament volunteers



Partnerships: Kay Read and Craig Jones



Hospitality (clockwise from left): Cheryl Mazerado, Maryon Evans, Lindy Hamilton, Kay Aspaugh and Nancy Feldman

Monday, Aug. 6

Monday Evening Charity Side Game (28 pairs)

- 1A John Ashton, Portland OR; Louis Beauchet, Sherwood OR
- 2A Alex Kornel — Barbara Seagram, Toronto ON
- 3A David Waterman — Terry Waterman, Saint George UT
- 1-2B Daryl Sallaz, Boise ID; Jeff Taggart, Caldwell ID
- 1-2B Kay Read — Rebecca Rodenbush, Boise ID
- 3B Arthur Crawford, Meridian ID; Gary Crupper, Boise ID
- 1C Donald Hanset, Sandpoint ID; Christiane Turner, Ketchum ID
- 2C Karen Eveland, Lewiston ID; Renee Petersen, Moscow ID

Monday Evening 299er Pairs (12 pairs)

- 1D/E Priscilla Braun, Boise ID; Charneth Belanger, San Rafael CA
- 2D/E/1F Cheryl Maderazo, Boise ID; Maryon Evans, Nampa ID
- 3D/E/2F Pete Peterson, Meridian ID; Janet Matthews, Boise ID

Monday Evening Swiss Teams (16 teams)

- 1A Dave Westfall — Charles Bennett, Spokane WA; William Harker, Santa Fe NM; Bruce Noda, Corte Madera CA
- 2A/1B/C Nancy Feldman — Karen Jean Boss — Richard Harris, Boise ID; Lyle Clafin, Eagle ID
- 3A Polly Dunn — Patrick Dunn, Bellevue WA; Rebecca Clough — Roger Clough, Culver City CA
- 2B Shay Kinney — Ray Kinney, Goodyear AZ; Deborah Lackey, Washougal WA; Reid Sherwin, Klamath Falls OR
- 3B Laura Gastelum, Torrance CA; Deborah Steffen — Julie Nadel — Ronald Morris, Santa Barbara CA
- 2C Shay Kinney — Ray Kinney, Goodyear AZ; Deborah Lackey, Washougal WA; Reid Sherwin, Klamath Falls OR

Tuesday, Aug. 7

Tuesday Open Stratified Pairs (20 pairs)

- 1A/B Aaron Cavender, Sandy UT; Steven Towner, Salt Lake City UT
- 2A Paul Gelb, Palm Springs CA; KC Jones, Boise ID
- 3A Alex Kornel — Barbara Seagram, Toronto ON
- 2B Peggy Lou Faylor, Nampa ID; Chester Youngblood, Ontario OR
- 3B/1C Gregory Said, Boise ID; Dave Forrey, Nampa ID
- 2C Fred Trenkel — Patricia Trenkel, Ontario OR
- 3C Glenda Bradley, Salt Lake City UT; Mary Greig, Manitowoc WI

Tuesday Morning Side Game (20 pairs)

- 1A/1B Ian Kirk — Deanna Birch, Portland OR
- 2-3A/B/1C Bruce Thornburgh, Boise ID; Brian Brady, Nampa ID
- 2-3A/B Sandra Watson — Gary Crupper, Boise ID
- 2C Barbara Dali, Hailey ID; Sue White, Ketchum ID
- 3C Karen Eveland, Lewiston ID; Renee Petersen, Moscow ID

Tuesday Afternoon Side Game (18 pairs)

- 1A/B Doris Zavadii, Meridian ID; Lucille Schmidt, Boise ID
- 2A/B Daniel Johnson — Robert Van Eyll, Boise ID
- 3A/B/1C Mary Ellen McFarlane — Pam Circuit, Idaho Falls ID
- 2C Barbara Dali, Hailey ID; Sue White, Ketchum ID
- 3C Mike Amspacher, Vancouver WA; Elsie Chan, Ridgefield WA

Tuesday Afternoon 299er Pairs (23 pairs)

- 1D/E Alice Kaye Guyer, Idaho Falls ID; Gerry Turner, Star ID
- 2D/E Janet Matthews, Boise ID; Donald Branton, Eagle ID
- 3D Lorraine Almy — Donald Almy, Edmonds WA
- 3E Pat Reiman, Kuna ID; Patricia McGlothin, Boise ID
- 1F Michael Mullen — Carolyn Tragesser, Meridian ID
- 2F Gayle Hanset, Sandpoint ID; Susan Macartney, Meridian ID

Tuesday Evening Side Game (12 pairs)

- 1A Leon Lowe, Fountain Hills AZ; Mark Itabashi, Murrieta CA
- 2A Daniel Hoekstra, Portland OR; Connie Marfell, Milwaukie OR
- 3A/1B Eileen Milligan — Gayle Peterson, Corvallis OR
- 2B Arthur Crawford, Meridian ID; Gary Crupper, Boise ID
- 3-4B Pete Grice, Boise ID; Robert Dutton, Bremerton WA
- 3-4B Kay Read — Rebecca Rodenbush, Boise ID

Tuesday Evening 299er Pairs (14 pairs)

- 1D Allen Jones — Stephen Heidel, Ketchum ID
- 2D Gerald Henggeler — Dauna Henggeler, Fruitland ID
- 3D Charlotte Riviera — Marjorie Bathum, Bellevue WA

- 1E Alice Kaye Guyer, Idaho Falls ID; Gayle Hanset, Sandpoint ID
- 2E/1F Janet Matthews, Boise ID; Donald Branton, Eagle ID
- 3E Pat Reiman, Kuna ID; Sharon Yahraes, Boise ID
- 2F Anne Oglevie — John Oglevie, Weiser ID

Tuesday Evening Swiss Teams (8 teams)

- 1A Bill Bradshaw, Billings MT; Tanya McCully, Whitefish MT; Stephen Nafus — Suzanne St. Thomas, Boise ID
- 2A Patrick Dunn — Polly Dunn, Bellevue WA; Rebecca Clough, Culver City CA; Wally Grimm, Palm Desert CA
- 3A/1B/C Rita Guzzard, Nine Mile Falls WA; Betty Glasser, Spokane WA; Ward Thompson — Diana Thompson, Penn Valley CA

Wednesday, Aug. 8

City of Trees Tues-Wed KO Bracket 1 (10 teams)

- 1 Laurie Rowe, Eugene OR; Merlin Vilhauer, Beaverton OR; Richard Carle, Longview WA; Irva Neyhart, Corvallis OR
- 2 Jon Brissman, Indianapolis IN; Rebecca Rogers, Henderson NV; Craig Kavin, Newbury Park CA; John Grantham, Bentonville AR
- 3-4 Howard Epley, Kent WA; Marty McCune — Mary McCune, Seattle WA; Barbara Nist, Seatac WA
- 3-4 Bruce Noda, Corte Madera CA; William Harker, Santa Fe NM; Charles Bennett — Dave Westfall, Spokane WA

City of Trees Tues-Wed KO Bracket 2 (9 teams)

- 1 Randal Gentillon — Jim Milam — Beth Milam, Idaho Falls ID; Ray Fink, Jackson WY
- 2 Scott Nason, Dallas TX; Alexander Wiles, Los Angeles CA; John Cissel — Craig Jones, Boise ID
- 3-4 Deborah Steffen — Julie Nadel — Ronald Morris, Santa Barbara CA; Laura Gastelum, Torrance CA
- 3-4 Clare Christiansen — Steve McCoy — Mardi Dennis, Oak Harbor WA; Susanne Thomas, Coupeville WA

City of Trees Tues-Wed KO Bracket 3 (10 teams)

- 1 Karen Eveland, Lewiston ID; Renee Petersen, Moscow ID; Donald Hanset, Sandpoint ID; Christiane Turner, Ketchum ID
- 2 Nancy Feldman — Karen Boss — Richard Harris, Boise ID; Lyle Clafin, Eagle ID
- 3-4 John Gitzen — Carol Holmes, Meridian ID; Margory Culver — Julia Christensen, Boise ID
- 3-4 Mary Bujanovich, St. George UT; Darlene Macdonald, Washington UT; Shirley Gilbreath, Eagle ID; Judy Hall, Ivins UT

Wednesday Open Pairs (44 pairs)

- 1A Mark Itabashi, Murrieta CA; Leon Lowe, Fountain Hills AZ
- 2A Louis Beauchet, Sherwood OR; John Ashton, Portland OR
- 3A Suzanne St. Thomas — Stephen Nafus, Boise ID
- 1B John Zamboni, Caldwell ID; Shay Kinney, Goodyear AZ
- 2B James Wheeler, Ridgefield WA; Marie Ashton, Portland OR
- 3B/1C Gregory Said, Boise ID; Dave Forrey, Nampa ID
- 2C Linda Brinton — Larry Chase, Boise ID
- 3C Gary Belew, Meridian ID; Matthew Thomas, Eagle ID

Wednesday Gold Point Pairs (44 pairs)

- 1C Evelyn St. Clair — Duane St. Clair, Boise ID
- 2C Charles Abrams — Arlene Rueb, Meridian ID
- 3C/1D Diane Strachan, Cedar City UT; Laura Blackman, St. George UT
- 2D/1E Ray Kinney, Goodyear AZ; Reid Sherwin, Klamath Falls OR
- 3D/2E Barbara Bain, Pocatello ID; Kay Bain, Ashland OR
- 3E Cheryl Maderazo — Janet Matthews, Boise ID

Wednesday Morning Side Game (20 pairs)

- 1A Jon Neimand, Eugene OR; James Smith, Mapleton OR
- 2A KC Jones, Boise ID; Bill Bradshaw, Billings MT
- 3A/1B/C Don Hanset, Sandpoint ID; Chris Turner, Ketchum ID
- 2B Kay Read — Daryl Sallaz, Boise ID
- 3B Steven Towner, Salt Lake City UT; Aaron Cavender, Sandy UT
- 2C Barbara Dali, Hailey ID; Sue White, Ketchum ID
- 3C Richard Munoz — Ann Munoz, Pocatello ID

Wednesday Afternoon Side Game (34 pairs)

- 1A Robin Rodger — Paul Darin, San Diego CA
- 2A Brenda Glaze, Anchorage AK; Margi Redden, Portland OR
- 3A Jon Neimand, Eugene OR; James Smith, Mapleton OR
- 1B Eileen Milligan — Gayle Peterson, Corvallis OR

- 2B/1C Barbara Dali, Hailey ID; Sue White, Ketchum ID
- 3B Ian Kirk — Deanna Birch, Portland OR
- 2C Helen Vanderwyk, Meridian ID; Anne Burton, Boise ID
- 3C Pam Circuit — Mary Ellen McFarlane, Idaho Falls ID

Wednesday Evening Side Game (14 pairs)

- 1A Bruce Noda, Corte Madera CA; William Harker, Santa Fe NM
- 2A Mary McCune — Marty McCune, Seattle WA
- 3A Howland Epley, Kent WA; Barbara Nist, Seatac WA
- 1B Rebecca Rodenbush — Kay Read, Boise ID
- 2B Mariam Saner, Vancouver WA; Rita Docken, La Quinta CA
- 3B Eileen Milligan — Gayle Peterson, Corvallis OR

Thursday, Aug. 9

Thursday Open Pairs (24 pairs)

- 1A Amy Casanova — Dewitt (Hal) Montgomery III, Portland OR
- 2A John Ashton, Portland OR; Michael Levy, Keizer OR
- 3A Daniel Hoekstra, Portland OR; Louis Beauchet, Sherwood OR
- 1B/C John Werbelow, Heber City UT; Carmen von Bothmer, Salt Lake City UT
- 2B Peter Andrews — Irma Andrews, Aptos CA
- 3B Svetlana Stojic, Salt Lake City UT; Michael Hurt, Boise ID
- 2C Candice Ragsdale, Taylorsville UT; David Lufkin, Salt Lake City UT
- 3C Nancy Raiche — Gerry Gastelum, Manhattan Beach CA

Tuesday-Thursday Morning KO Bracket 1 ... (6 teams)

- 1 Rebecca Clough — Roger Clough, Culver City CA; Polly Dunn — Pat Dunn, Bellevue WA
- 2 Marilyn Edwards — Clyde Coon — Al Babineau, Boise ID; Bill Cook, Twin Falls ID

Tuesday-Thursday Morning KO Bracket 2 ... (8 teams)

- 1 Margi Redden, Portland OR; Elsie Chan, Ridgefield WA; Mike Amspacher, Vancouver WA; Glenda Bradley, Salt Lake City UT
- 2 Laura Gastelum, Torrance CA; Julie Nadel — Deborah Steffen — Ronald Morris, Santa Barbara CA
- 3-4 David McLeod, Meridian ID; Betty Coursey — Richard Mallon — Phil Emerson, Boise ID

Thursday Morning Side Game (16 pairs)

- 1A Mike Dalton, Palm Coast FL; Estelle Kevitch, Salt Lake City UT
- 2A Paul Darin — Robin Rodger, San Diego CA
- 3A/1B/C Ron Fleming — Betty Glasser, Spokane WA
- 2B/C Patricia Robbins — Orrin Robbins, Olympia WA
- 3B Patricia Wells, Kuna ID; Patricia Coontz, Boise ID

Thursday Afternoon Side Game (32 pairs)

- 1A Theresa Barthels — Peter Barthels, Cheney WA
- 2A/1B Ian Kirk — Deanna Birch, Portland OR
- 3A/2B Rita Docken, La Quinta CA; Mariam Saner, Vancouver WA
- 3-4B Julie Nadel — Ronald Morris, Santa Barbara CA
- 3-4B William Neely — Dan Neely, Boise ID
- 1C Beverly Fransen — Kristen Boesiger, Boise ID
- 2C Pam Circuit — Mary Ellen McFarlane, Idaho Falls ID
- 3C Helen Vanderwyk, Meridian ID; Anne Burton, Boise ID

Thursday Afternoon 299er Pairs (32 pairs)

- 1D Barbara Moser, Star ID; Alice Kohtz, Boise ID
- 2D Robert Pfeffer, Bend OR; Clifford Shaw, Wesley Chapel FL
- 3D Charlotte Riviera — Marjorie Bathum, Bellevue WA
- 1E Mary Ann Martini — Patt Elison-Bowers, Boise ID
- 2E Alice Kaye Guyer, Idaho Falls ID; Gerry Turner, Star ID
- 3E/1F Jayne James — Gary Bair, Boise ID
- 2F Kenneth Kress — Karen Kress, Emigrant MT

Thursday Evening Side Game (8 pairs)

- 1A Linda Brinton — Larry Chase, Boise ID
- 2A Charles Burns — Lynda Hirst, Vancouver WA
- 3A Robert Donaldson, Ogden UT; Lewis Boynton, Kaysville UT

Thursday Evening 299er Pairs (12 pairs)

- 1D Robert Pfeffer, Bend OR; Clifford Shaw, Wesley Chapel FL
- 2D Sid Paskett — Miki Paskett, Orem UT
- 3D Allen Jones — Stephen Heidel, Ketchum ID
- 1E Donald Branton, Eagle ID; Janet Matthews, Boise ID
- 2E Pat Reiman, Kuna ID; Sharon Yahraes, Boise ID

Boise: Johansson will manage OTR

Continued from Page 1

unprepared. He fielded the many complaints with aplomb.

Nancy Jonske, who lives in Portland, is the new education liaison. Nancy has served on the Unit 487 board for several years as president and has been actively involved in an ongoing teaching program at Catlin Gabel Middle School. Nancy has invested much time attending seminars and accreditation programs, including the American Bridge Teachers Association conference, Audrey Grant's 2/1 conference, multiple Barbara Seagram seminars and Learn Bridge in a Day.



Nancy Jonske

The district's co-tournament manager position is still open, but if you are interested you will have to wait until after the Oregon Trail Regional in February. **Jean Johansson** of Portland has offered to fill in on an interim basis.

Johansson, who had done years of major project management work be-

fore retiring, sees this as simply another project.

"My legacy to the district will be a comprehensive work plan, hopefully to serve as a useful tool for the ongoing tournament managers," she says.

"I look forward to working with the tournament directing staff; the partnership, hospitality and caddy master chairs, and the Portland and Vancouver host units, as well as hotel staff and our own contracts manager and business manager. It does indeed take a village."

We welcome and thank Johansson for stepping up for the OTR. And we can't resist the chance to thank the aforementioned business and contracts managers, **Marie Ashton** and **Marilyn Vilhauer**, who provide much needed experience and continuity for our district's tournaments.

If you are interested in the co-tournament manager position, please see the advertisement on page 16.

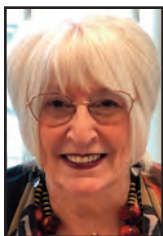

Jean Johansson

Vilhauer: Term limits; new title for CEO

Continued from Page 1

The board continues to work on increasing memberships and I hope will start soon lending more help to the clubs as well as trying to find ways to get online players out to the clubs and tournaments. If you have any good ideas, be sure to send them to me at my email shown below.

Here are a few of the board actions. See the ACBL website for more information.

- ♦ The board passed a term limit of four, starting in 2019. I am in my third term and most likely I'd like to serve one more term to see the board through the redistricting issues.

- ♦ Masterpoint awards for NAP and GNT have been increased. These new awards can be found in the minutes for board meetings on the ACBL website.

- ♦ The CEO title has been changed to executive director.

- ♦ The ACBL incurred a big expense reducing its dependency on the AS400 computer system currently being used in Horn Lake. The programs will need to be moved to cloud-based technology. The result: a \$345,000 write-off in 2018.

- ♦ The ACBL search committee is still searching for a new executive director. Cur-

rently, Joe Jones, CFO, is serving as acting ED.

Every five years we are allocated \$30,000 from the national Charity Foundation. We can allocate that amount to, at most, seven charities. I will send out a letter to all the units with further details and then I will have a small group help me make the final decisions. I am going to look into a way to help the people in the Redding area, which is still suffering from the Carr fire.

Each year I am able to nominate two to four new members to the Goodwill Committee. If you know of someone who represents goodwill, send me a recommendation.

Plan now to attend the Hawaii Fall NABC. It's a wonderful venue, both for playing bridge and for time away from the tables. Marilyn and I attend the January regional in Hawaii every year and we can give you lots of ideas for making your trip a little more economical if you choose to stay away from the wonderful Hilton Hawaiian Village. We may or may not share the name of our favorite restaurant where we enjoy a fabulous \$15 lobster dinner.

It's a great year for regionals in D20. See you in soon.

District director **Merlin Vilhauer** can be reached at district20director@acbl.org.

Player roundup

By Amy Casanova
The Trumpet

At the Boise Regional, we asked players this question: *What might cause you to break up with a bridge partner?* Here are their answers.



Diane Lusin

If they were condescending, arrogant and a know-it-all.

Diane Lusin
Billings MT

If someone were too critical and never improved their behavior.

Julia Christensen
Boise



Julia Christensen



Deborah Lackey

I don't like to feel pressured to play conventions or systems I don't want to play.

Deborah Lackey
Education liaison

If someone were manipulative, or a hand hog.

Sharon Yahraes
Boise



Sharon Yahraes



Barbara Seagram

Being rude to opponents.

Barbara Seagram

Getting berated, especially at the table.

Jim Wheeler
Tournament manager

A lack of commitment to the game.

Brenda Glaze
Anchorage AK



Brenda Glaze



Pat Reiman

If it seemed they were not enjoying the game.

Pat Reiman
Kuna ID

Double dummy hand analysis, postmortem.

Craig Jones
Boise



Craig Jones



Tricia Wells

If my partner's behavior made it difficult to find teammates.

Tricia Wells
Kuna ID

Oh, I can't do that, it would cost millions.

Donna Wisdom
Boise,

who plays with her husband Don



Donna Wisdom

Thursday Evening Swiss Teams (9 teams)

- 1A Randal Gentillon — Jim Milam — Beth Milam, Idaho Falls ID; Ray Fink, Jackson WY
- 2-3A/1B/C Carol Holmes — John Gitzen, Meridian ID; Margory Culver — Julia Christensen, Boise ID
- 2-3A Mike Dalton, Palm Coast FL; Estelle Kevitch, Salt Lake City UT; Julianne Adair — Doug Adair, Midvale UT
- 2B/C Ron Fleming — Ginny Davis — Susan Norton — Dottie Larson, Spokane WA

Friday, Aug. 10

Treasure Valley Thurs-Fri KO Bracket 1 (12 teams)

- 1 John Grantham, Bentonville AR; Craig Kavin, Newbury Park CA; Jon Brissman, Indianapolis IN; Rebecca Rogers, Henderson NV
- 2 Mark Itabashi, Murrieta CA; Leon Lowe, Fountain Hills AZ; Bruce Noda, Corte Madera CA; William Harker, Santa Fe NM; Charles Bennett — Dave Westfall, Spokane WA
- 3-4 Jamie Newman — Ron Jauch, Nevada City CA; Jon Neimand, Eugene OR; James Smith, Mapleton OR
- 3-4 Lee Payne — Jimmy Payne, Salt Lake City UT; James Siegel, Ketchum ID; Buzz Farnes, Midvale UT

Treasure Valley Thurs-Fri KO Bracket 2 (13 teams)

- 1 Mardi Dennis — Steve McCoy — Clare Christiansen, Oak Harbor WA; Susanne Thomas, Coupeville WA
- 2 Judy Stauffer — Pat Sales, Boise ID; Candace Bonawitz, McCall ID; Arlene Rueb, Meridian ID
- 3-4 Bill Light — Ucky Light — Evelyn St. Clair — Duane St. Clair, Boise ID
- 3-4 Pete Grice — Gregory Said, Boise ID; Bob Dutton, Bremerton WA; Dave Forrey, Nampa ID

Friday Open Pairs (42 pairs)

- 1A Irva Neyhart, Corvallis OR; John Ashton, Portland OR
- 2A Michael Levy, Keizer OR; Dewitt (Hal) Montgomery, Portland OR
- 3A Bill Bradshaw, Billings MT; Tanya McCully, Whitefish MT
- 1B/C Cindy Maher — Cindy Amos, Boise ID
- 2B/C Alexander Wiles, Los Angeles CA; Scott Nason, Dallas TX
- 3B/C Kay Read — Rebecca Rodenbush, Boise ID

Friday Gold Point Pairs (40 pairs)

- 1C/D Janet Mayfield — James Mayfield, Hailey ID
- 2C Karen Eveland, Lewiston ID; Renee Petersen, Moscow ID
- 3C Ruby Boyd — Marolyn Poole, Ontario ID
- 2D Mary Hanni — Bruce Hanni, Eagle ID
- 3D/1E Robert Pfeffer, Bend OR; Clifford Shaw, Wesley Chapel FL
- 2E Greg Wilson — Beverly Fraser, Boise ID
- 3E John Werbelow, Heber City UT; Carmen von Bothmer, Salt Lake City UT

Friday Morning Side Game (18 pairs)

- 1A Peter Barthels — Theresa Barthels, Cheney WA
- 2A Mark Itabashi, Murrieta CA; Leon Lowe, Fountain Hills AZ
- 3A/1B Bill Neely — Dan Neely, Boise ID

- 2B/1C Ron Fleming — Dottie Larson, Spokane WA
- 3B Laura Gastelum, Torrance CA; Deborah Steffen, Santa Barbara CA
- 2C Allen Jones — Stephen Heidel, Ketchum ID

Friday Afternoon Side Pairs (36 pairs)

- 1A Julianne Adair — Doug Adair, Midvale UT
- 2A Alex Kornel — Barbara Seagram, Toronto ON
- 3A Charles Burns — Lynda Hirst, Vancouver WA
- 1B/C Betty Glasse — Linda Echtenkamp, Boise ID
- 2B/C William Cook — Brenda Larsen, Twin Falls ID
- 3B Linda Morrison, Bellevue WA; Maureen Schroder, Kirkland WA
- 3C Mike Ampsacher, Vancouver WA; Elsie Chan, Ridgefield WA

Friday Evening Side Game (13 pairs)

- 1A Jimmy Payne — Lee Payne, Salt Lake City UT
- 2A Brenda Glaze, Anchorage AK; Margi Redden, Portland OR
- 3A Mary Greig, Boise ID; Connie Marfell, Milwaukie OR
- 1B Mariam Saner, Vancouver WA; Rita Docken, La Quinta CA
- 2B Eileen Milligan — Gayle Peterson, Corvallis OR

Saturday, Aug. 11

Saturday Open Pairs (24 pairs)

- 1A Louis Beauchet, Sherwood OR; Laurie Rowe, Eugene OR
- 2A Irva Neyhart, Corvallis OR; John Ashton, Portland OR
- 3A Mark Itabashi, Murrieta CA; Leon Lowe, Fountain Hills AZ
- 1B/C Candice Ragsdale, Taylorsville UT; David Lufkin, Salt Lake City UT
- 2B Daniel Johnson — Philip Fast, Boise ID
- 3B/2C Gary Belew, Meridian ID; Matthew Thomas, Eagle ID

Saturday Gold Point Pairs (24 pairs)

- 1C/D Mella-Dee Mayberry — Philip Mayberry, Payette ID
- 2C Susan Servais, Bellevue WA; Sharon Riddle, Kirkland WA
- 3C/2D/1E Jayne James, Boise ID; David McLeod, Meridian ID
- 3-4D/2E Victoria Hess, Jackson WY; Diane Lusin, Billings MT
- 3-4D James Mayfield — Janet Mayfield, Hailey ID
- 3E Shannon Luck, Sandy UT; Aaron Dewell, Coalville UT

Hells Canyon Sat Compact KO Bracket 1 (6 teams)

- 1 Craig Kavin, Newbury Park CA; John Grantham, Bentonville AR; Rebecca Rogers, Henderson NV; Jon Brissman, Indianapolis IN
- 2 Barbara Nist, Seatac WA; Howard Epley, Kent WA; Marty McCune — Mary McCune, Seattle WA

Hells Canyon Sat Compact KO Bracket 2 (8 teams)

- 1 Cindy Amos — Cindy Maher — Al Babineau — Marilyn Edwards, Boise ID
- 2 Greg Wilson — Beverly Fraser, Boise ID; Leslie Muir — Art Crawford, Meridian ID

Saturday Morning Side Game (26 pairs)

- 1A/C Mike Ampsacher, Vancouver WA; Elsie Chan, Ridgefield WA
- 2A/B Joe Blackford, Lincoln CA; Don Robinson, Boise ID
- 3A/B Bill Neely — Dan Neely, Boise ID
- 2C Mary Ellen McFarlane — Pam Circuit, Idaho Falls ID

- 3C Theresa Choma, Hailey ID; Sandra Flattery, Ketchum ID

Saturday Afternoon Side Game (18 pairs)

- 1A Alex Kornel — Barbara Seagram, Toronto ON
- 2A/1B Richard Mallon — Betty Coursey, Boise ID
- 3A/2B Elazar Friedman, Middleton ID; Paul Penland, Eagle ID
- 3B/1C Donna Janicek, Eagle ID; Peggy Lou Faylor, Nampa ID
- 2C Pam Circuit — Mary Ellen McFarlane, Idaho Falls ID

Saturday Evening Swiss Teams (9 teams)

- 1A William Harker, Santa Fe NM; Bruce Noda, Corte Madera CA; Dave Westfall — Charles Bennett, Spokane WA
- 2A Lee Payne — Jimmy Payne, Salt Lake City UT; James Siegel, Ketchum ID; Buzz Farnes, Midvale UT
- 3A Randal Gentillon — Jim Milam — Beth Milam, Idaho Falls ID; Ray Fink, Jackson WY
- 1B Nelle Lucas — Jim Lucas, Idaho Falls ID; Julianne Adair — Doug Adair, Midvale UT
- 2B Dennis Kendig — Judd Robbins, Ashland OR; Theresa Choma, Hailey ID; Sandra Flattery, Ketchum ID

Sunday, Aug. 12

Sunday AXY Swiss (14 teams)

- 1A Bill Bradshaw, Billings MT; Suzanne St. Thomas, Boise ID; Patty Holmes, Las Vegas NV; Tanya McCully, Whitefish MT
- 2A Rebecca Rogers, Henderson NV; Craig Kavin, Newbury Park CA; John Grantham, Bentonville AR; Jon Brissman, Indianapolis IN; Marie Ashton, Portland OR
- 3A Jamie Newman — Ron Jauch, Nevada City CA; Jon Neimand, Eugene OR; James Smith, Mapleton OR
- 1X/Y David Taylor, Seattle WA; Amy Casanova — Margi Redden, Portland OR; Brenda Glaze, Anchorage AK
- 2X Randal Gentillon — Jim Milam — Beth Milam, Idaho Falls ID; Ray Fink, Jackson WY
- 3X Lee Payne — Jimmy Payne, Salt Lake City UT; James Siegel, Ketchum ID; Buzz Farnes, Midvale UT

Sunday BCD Swiss (17 teams)

- 1B/C Bill Neely — Dan Neely — Larry Chase — Linda Brinton, Boise ID
- 2B/C Anita Hansen — Erik Hansen, Caldwell ID; Ruby Boyd, Ontario OR; Glenora Wright, Fruitland ID
- 3-4B/C Doris Zavadil, Meridian ID; Lucille Schmidt, Boise ID; Mary Hanni — Bruce Hanni, Eagle ID
- 3-4B/C Carol Holmes, Meridian ID; Marge Culver, Boise ID; Peggy Lou Faylor, Nampa ID; Donna Janicek, Eagle ID
- 1D Marilyn Brown — Perry Brown — Lindy Hamilton — Kay Alspaugh, Boise ID
- 2D Karen Boss — Nancy Feldman — Richard Harris, Boise ID; Lyle Claffin, Eagle ID

Evening Side Game Series (99 players)

- 1 Connie Marfell, Milwaukie OR
- 2-3 Marty McCune — Mary McCune, Seattle WA

City of Trees Mon-Tues Knockout



Merlin Vilhauer, Laurie Rowe, Irva Neyhart, Rich Carle



Irva Neyhart, John Ashton
Friday Open Pairs

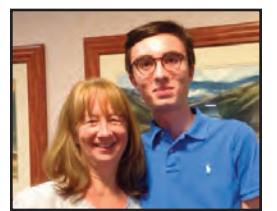

Laurie Rowe, Louis Beauchet
Saturday Open Pairs



Hal Montgomery, Amy Casanova
Thursday Open Pairs



John Ashton, Louis Beauchet
Monday Open Pairs



Duane & Evelyn St. Clair
Wednesday Gold Pairs
with Kay Aspaugh (center)



Barbara Seagram, Alex Kornel
Saturday Afternoon Side Pairs

Top masterpoint winners

Total masterpoints: 4443.72 earned by 352 players. Total attendance: 733 tables.

1	91.16	John Ashton, Portland OR	122	11.00	Mariam Saner, Vancouver WA
2	84.77	Jon Brissman, Indianapolis IN	123	10.73	Margory Culver, Boise ID
	84.77	John Grantham, Bentonville AR	124	10.54	KC Jones, Boise ID
	84.77	Craig Kavin, Newbury Park CA	125	10.53	Ruby Boyd, Ontario OR
5	83.75	Irva Neyhart, Corvallis OR	126	10.31	Gary Crupper, Boise ID
6	82.93	Rebecca Rogers, Henderson NV	128	10.21	Kathy Downen, Boise ID
7	72.47	Mark Itabashi, Murrieta CA	134	9.89	Candace Bonawitz, McCall ID
	72.47	Leon Lowe, Fountain Hills AZ	137	9.64	James Wheeler, Ridgefield WA
9	69.97	Louis Beauchet, Sherwood OR	138	9.56	Gary Belew, Meridian ID
10	61.61	Laurie Rowe, Eugene OR	142	9.27	Bruce Thornburgh, Boise ID
11	58.60	William Harker, Santa Fe NM		9.27	Brian Brady, Nampa ID
	58.60	Bruce Noda, Corte Madera CA		9.22	Lucille Schmidt, Boise ID
13	57.00	Bill Bradshaw, Billings MT		9.22	Doris Zavadil, Meridian ID
14	55.38	Dave Westfall, Spokane WA	146	9.21	David McLeod, Meridian ID
	55.38	Charles Bennett, Spokane WA	147	9.07	Robert Pfeffer, Bend OR
16	53.11	Tanya McCully, Whitefish MT		9.07	Paul Penland, Eagle ID
17	52.35	Richard Carle, Longview WA	150	9.00	Daryl Sallaz, Boise ID
	52.35	Merlin Vilhauer, Beaverton OR	151	8.99	Leslie Muir, Meridian ID
19	46.30	Hal Montgomery, Portland OR	152	8.84	Jeff Taggart, Caldwell ID
20	43.89	Michael Levy, Keizer OR	153	8.63	John Gitzen, Meridian ID
21	39.48	Polly Dunn, Bellevue WA	154	8.53	Marie Ashton, Portland OR
	39.48	Patrick Dunn, Bellevue WA	155	8.43	Janet Matthews, Boise ID
23	38.91	Suzanne St. Thomas, Boise ID		8.43	Daniel Johnson, Boise ID
24	38.87	James Milam, Idaho Falls ID	157	8.26	Donald Robinson, Boise ID
	38.87	Beth Milam, Idaho Falls ID	158	8.17	Deborah Lackey, Washougal WA
26	35.71	Howard Epley, Kent WA	161	8.14	Betty Coursey, Boise ID
	35.71	Barbara Nist, Seatac WA	163	8.06	Matthew Thomas, Eagle ID
28	34.10	Jon Neimand, Eugene OR	164	7.98	Reid Sherwin, Klamath Falls OR
	34.10	James Smith, Mapleton OR		7.98	Ray Kinney, Goodyear AZ
30	30.18	Marty McCune, Seattle WA	166	7.95	Bruce Hanni, Eagle ID
	30.18	Marty McCune, Seattle WA		7.95	Bruce Hanni, Eagle ID
32	29.58	Roger Clough, Culver City CA	170	7.71	Julia Christensen, Boise ID
	29.58	Rebecca Clough, Culver City CA	171	7.56	Charles Burns, Vancouver WA
34	29.10	Ray Fink, Jackson WY	172	7.41	Dottie Larson, Spokane WA
	29.10	Randal Gentillon, Idaho Falls ID	173	7.35	Gerry Turner, Star ID
36	28.52	Barbara Seagram, Toronto ON	174	7.30	Shirley Gilbreath, Eagle ID
	28.52	Alex Kornel, Toronto ON		7.29	Philip Mayberry, Payette ID
38	26.95	James Siegel, Ketchum ID	110	12.20	Mella-Dee Mayberry, Payette ID
	26.95	Buzz Farnes, Midvale UT		12.20	Gayle Peterson, Corvallis OR
40	26.48	Stephen Nafus, Boise ID		12.20	Eileen Milligan, Corvallis OR
41	25.92	Margi Redden, Portland OR	113	12.15	Clyde Coon, Boise ID
42	25.84	Ron Jauch, Nevada City CA	114	11.78	Judy Stauffer, Boise ID
	25.84	Jamie Newman, Nevada City CA		11.65	Carol Holmes, Meridian ID
			116	11.65	Carol Holmes, Meridian ID

The Longest Day District 20 raises \$25,000

District 20 clubs, units and players raised more than \$25,000 for the Alzheimer's Association in events associated with The Longest Day in June.

Seventeen clubs and units participated, helping the ACBL raise nearly \$1.2 million. Contributions from D20 were up 57% over last year.

Leading the district once again was Boise Unit 394, which raised almost \$5,800, up 54% from last year (see story, page 14).

The district's easternmost unit was followed by Unit 461, southernmost on the mainland, raising \$3,225, a 68% increase. The other southernmost unit, Hawaii's Big Island, came in fourth with \$1,911 from the Hilo Bridge Club.

Four Portland/Vancouver-area clubs participated, collectively raising \$6,850, led by Portland Bridge Club's \$2,441.

The largest percentage increase was by the Redding club, which tripled last year's effort with over \$1,600.

A pair of smaller clubs on the Oregon coast participated for the first time. Clubs in Bandon and North

Top 10 fundraisers in D20

Boise Unit 394	\$5785
Unit 461 Grass Valley CA	\$3225
Portland Bridge Club	\$2441
Vancouver (WA) Bridge Club	\$2092
Hilo (HI) Bridge Club	\$1911
Albany/Corvallis	\$1700
Redding (CA) DBC	\$1633
Ace of Clubs, Lake Oswego OR	\$1402
Longview (WA) Bridge Club	\$920
Multnomah Athletic Club	\$915



Boise players Nancy Feldman, Darryl Sallaz, Pete Grice and Cheryl Maderazo toast their success.

Bend, 27 miles apart and attended mostly by the same people, raised \$574 and \$500 respectively.

Clubs had the option to hold games on the day of their choice, June 17-23.



Chris's Corner

ACBL tournament director
Chris Weigand answers your
questions on rulings.

Don't be afraid to call a director

As a tournament director, my least favorite calls are those made after the fact or not made at all.

Sometimes well-intentioned players make decisions at the table without all of the facts or without a complete knowledge of the applicable laws. Players should call the director any time there is an irregularity or a procedural question.

It is much easier for directors to deliver rulings at the time of the irregularity rather than after things have progressed further. Calling the director is not calling the police; it is asking a neutral party, well-versed in the laws, to come to the table to help adjudicate a situation.

Here is hand that required a ruling from me on a recent game. Spades are trump and spots are approximate:

♠K 8 7 5		
♥K Q		
♦10 9 3		
♣—		
♠—	♠6	
♥10 9 8	♥7 5	
♦7 2	♦J 8 6 4	
♣J 4 3 2	♣Q 6	
	♠Q J 10 4 2	
	♥—	
	♦A K Q 5	
	♣—	

At the point in play illustrated above, South claimed the remainder of the tricks without mention of the outstanding trump or any line of play. Will South lose a trick to the trump?

Irregular claims are not infractions and are not subject to automatic trick adjustments or penalties like an established revoke. When a director is called to adjudicate a claim, it is her job to try to figure out what is most equitable for both sides, with questionable points being ruled against the claimer. But it is not an automatic windfall against the claiming side.

In the example here, I tried to figure out some details. For example, who is on lead? (South.) Was there a statement about the line of play made by declarer? (No, just some notion of spades/diamonds are good.) Did declarer mention outstanding trump? (No.) Did declarer's previous line of play show that he may have miscounted trump? (Yes, she pulled one and then stopped even though one was left.) Is there a normal line of play for declarer that would be unsuccessful? (No. Even if declarer tried to play the diamonds before the spades, since East is the defender with the length in diamonds, she has to follow to all of the diamonds before she would be able to ruff.)

So South's claim was allowed to stand, even if it was poorly stated.

Note: The ACBL Board of Directors recently decided to make the Electronic Device Policy consistent across all regional events. This will be a harsher policy than usual at D20 events. You can read about the policy here:

<https://tinyurl.com/y9yaf8y7>

Best advice: Turn your devices off when in the playing room.

Wiegand is an ACBL tournament director. You can reach her with ruling questions at chris.wiegand@acbl.org.



TOURNAMENT CALENDAR

DISTRICT 20 REGIONALS & SECTIONALS

SEPTEMBER 2018

7-9	Eureka Sectional	Ocean View Mobile Home Park, McKinleyville CA
8-9	Portland Sectional	Montgomery Park, Portland OR
14-16	Boise Fall Sectional	Wyndham Garden Hotel, Boise ID
14-16	Honolulu Sectional	Ala Wai Clubhouse, Honolulu HI
14-16	Rogue Valley Sectional	Dan Voorhies Bridge Center, Phoenix OR

OCTOBER 2018

Oct 1-7

12-14	OREGON COAST REGIONAL	Seaside Convention Center, Seaside OR
13-14	Gold Country Sectional	St. Canice Center, Nevada City CA
20-21	Vancouver Fall NLM Sectional	Vancouver Bridge Club, Vancouver WA
25-28	North American Pairs	Online at various locations
	Central Oregon Coast Sectional	Shilo Inn, Newport OR

NOVEMBER 2018

2-4	Nampa-Caldwell Harvest Sectional	Nampa Hispanic Cultural Center, Nampa ID
2-4	Redding Fall Sectional	Win-River Hotel & Casino, Redding CA
3-4	East & West Willamette Sectional	Portland Bridge Club and the Ace of Clubs
10-11	Heart of the Valley 299er Sectional	Heart of the Valley Bridge Center, Corvallis OR
10-11	Rogue Valley I/N Sectional	Dan Voorhies Bridge Center, Phoenix OR
10-11	Vancouver Fall Sectional	Washington School for the Deaf, Vancouver WA
16-18	Honolulu Sectional	Ala Wai Clubhouse, Honolulu HI

Nov 22-Dec 2

FALL NABC

Hilton Hawaiian Village, Honolulu HI

DECEMBER 2018

3-9	Western Conference STaC	Local clubs
-----	-------------------------	-------------

JANUARY 2019

Jan 7-13

12-13	HAWAII REGIONAL	Prince Waikiki, Honolulu HI
25-27	Vancouver Winter NLM Sectional	Vancouver Bridge Club, Vancouver WA
	Garden Island Sectional	Sun Village Condominium Recreation Center, Lihue HI

FEBRUARY 2019

8-10	Maui Sectional	Kenolio Recreation Complex, Kihei HI
Feb 18-24	OREGON TRAIL REGIONAL	Vancouver Hilton, Vancouver WA
22-24	Big Island Sectional	Makua Lani Christian Academy, Kailua Kona HI

MARCH 2019

1-3	Honolulu Sectional	Ala Wai Clubhouse, Honolulu HI
15-17	Heart of the Valley Sectional	Linn County Fair/Expo Center, Albany OR
15-17	Almond Blossom Sectional	Chico Women's Club, Chico CA
29-31	Rogue Valley Spring Sectional	Dan Voorhies Bridge Center, Phoenix OR

APRIL 2019

12-13	Eugene 299er Sectional	Emerald Bridge Club, Springfield OR
12-14	Redding Spring Sectional	Win-River Hotel & Casino, Redding CA
13-14	Vancouver Spring Sectional	Washington School for the Deaf, Vancouver WA
20-21	Grand National Teams - Open & B	Online at various locations
26-28	Seaside Sectional	Seaside Convention Center, Seaside OR

MAY 2019

4-5	Grand National Teams - A & C	Online at various locations
6-12	Western Conference STaC	Local clubs
May 13-19	ROGUE VALLEY REGIONAL	Inn at the Commons, Medford OR
17-19	Honolulu Sectional	Ala Wai Clubhouse, Honolulu HI

TOURNAMENTS IN NEIGHBORING DISTRICTS

DISTRICT 19: www.d19.org

Oct. 19-21	Grandview Sectional WA
Oct. 29-Nov. 4	Leavenworth Regional WA
Nov. 10-11	Seattle I/N Sectional WA
Dec. 7-9	Tacoma Sectional, Fircrest WA
Jan. 25-27	Vancouver Sectional BC
Feb. 8-10	Bellingham Sectional WA
Feb. 8-10	Seattle Sectional, Everett WA
April 8-14	Victoria Regional WA

DISTRICT 21: www.d21acbl.com

Sept. 29-30	Santa Rosa Sectional CA
Oct. 4-7	Carson City Sectional NV
Oct. 6-7	Modesto Sectional CA
Oct. 15-21	Reno Regional, Sparks NV
Nov. 17-18	Oakland Sectional CA
Nov. 30-Dec. 2	Sacramento Sectional, Orangevale CA
Dec. 31-Jan. 6	Monterey Regional CA
Jan. 26-27	Livermore Sectional CA
March 9-10	Santa Rosa Sectional CA
March 27-31	Reno Sectional, Sparks NV
May 27-June 2	Sacramento Regional CA

DISTRICT 18: www.wasumi.org

Sept. 24-30	Missoula Regional MT
Oct. 10-12	World Senior Games, Washington UT
Oct. 26-28	Ogden Sectional, Roy UT
Jan. 18-20	Salt Lake City Sectional UT
Feb. 8-10	St. George Sectional UT

DISTRICT 17: www.d17acbl.org

Oct. 8-14	Colorado Springs Regional CO
Nov. 5-9	Las Vegas Sectional NV
Nov. 14-18	Tucson Sectional and I/N Regional AZ
Jan. 18-21	Sin City Classic, Las Vegas NV
Jan. 24-27	Yuma Sectional AZ
Jan. 21-27	Albuquerque Regional NM
Feb. 25-March 3	Tucson Regional AZ

DISTRICT 22: acbldistrict22.com/d22

Oct. 29-Nov. 4	Ventura Regional CA
Dec. 10-16	Palm Springs Regional, Rancho Mirage CA
Jan. 10-13	Palm Springs I/N Regional CA
Jan. 28-Feb. 3	Riverside Regional CA
April 15-21	San Diego Regional CA

NORTH AMERICAN BRIDGE CHAMPIONSHIPS

Nov. 22 - Dec. 2
March 21-31
July 18-28
Nov. 28 - Dec. 8

Fall 2018
Spring 2019
Summer 2019
Fall 2019

Hilton Hawaiian Village, Honolulu HI
Sheraton & Crowne Plaza, Memphis TN
Cosmopolitan, Las Vegas NV
Marriott Marquis, San Francisco CA